

Half Forecayest 80 gms  
Length of Gun Deck 150' 0"  
Breadth Moulded 40' 0"

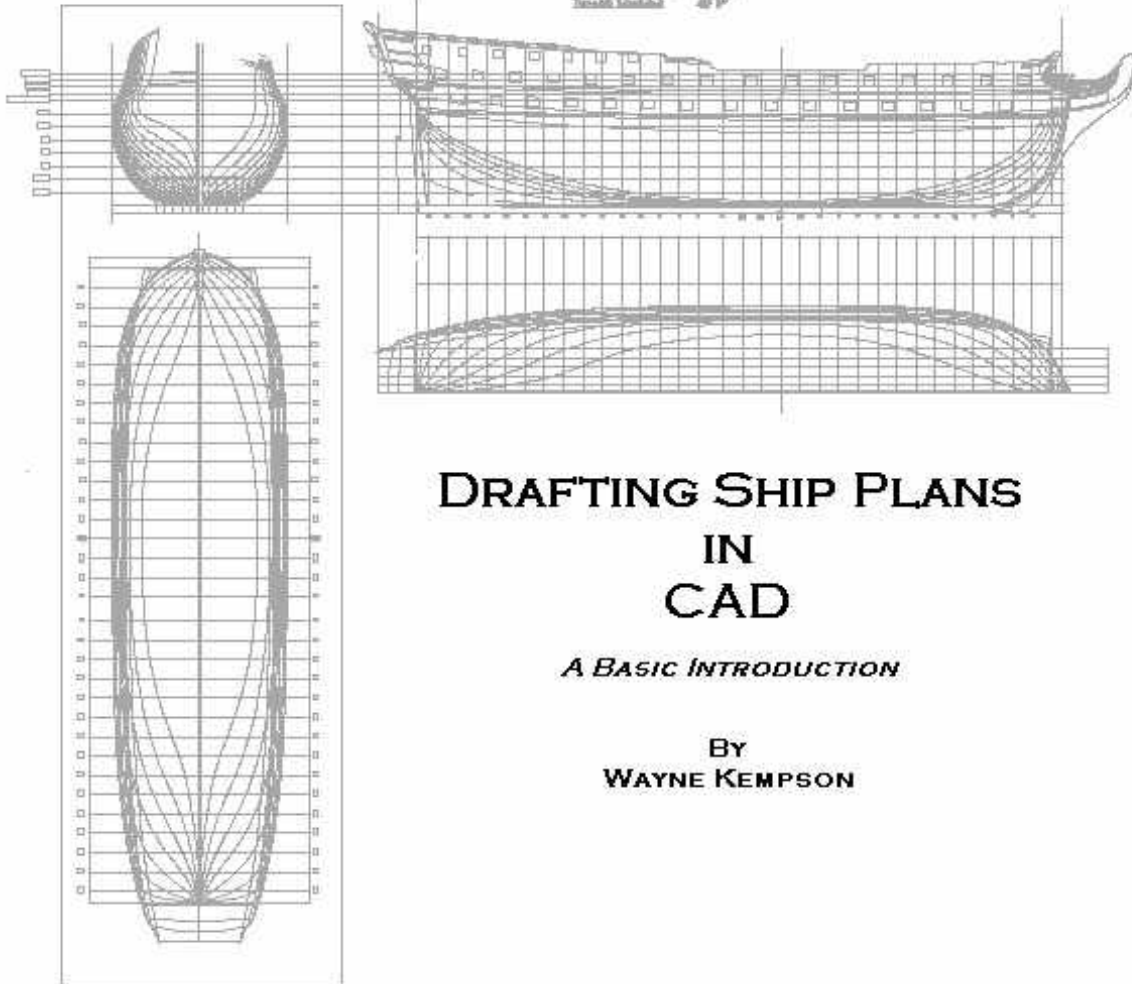

# DRAFTING SHIP PLANS IN CAD

*A BASIC INTRODUCTION*

By  
WAYNE KEMPSON

## Introduction

A model ship, well built and smartly rigged, appeals to the heart, mind and soul of some of us. Perhaps you have paused to admire the lines of the hull as you imagined how the ship would have moved through the water. Or you may have lingered in consideration of how the vessel's body would have served her purpose for war or commerce. Indeed, if you have ever looked at a model ship and felt a bit of wonder fill your heart, then you can appreciate why we think a model ship something beyond treasure. The well-done ship model sends her builder down paths of history and science, thereby linking the humanities and the hard sciences in a single endeavor. For those who think of such things, a well-built ship model can be an endeavor of the spirit transcending the mundane by lifting the soul's sails on imagined winds.

### Kits

My entry into building model ships came by way of kits. Today, it is common to decry the kit built ship. For reasons of economics and profit, kits often contain noticeable compromises and inaccuracies. But without a kit, I would not have learned bow from stern. Much can be learned from books and articles, but there is a kind of knowledge that comes only from using one's own hands. For that task a kit is not a bad place to start.

I like to think of model kits as teaching tools. Supposedly, research work has been done, plans drawn up, materials gathered and so forth by the kit manufacturer. The kit designer has made a lot of the decisions for the new builder so that time and energy can concentrate on the physical task of construction.

The time comes, however, when you want to build a ship for which there is no kit. Or you may have discovered that the kit maker has not produced a model as accurate as you want to make. And it just may be the case that you want to delve deeper into the hobby.

For whatever reason, you have decided that you want to work directly from a set of plans beyond the limited sheets found even in the best kits.

### Plans

There are many sources for ship plans, but there may be only one source for a plan of the ship you want to build. Decide to build the *USF Constitution* or *HMS Victory* and your problem is choosing which set of plans to employ. On the other hand, choose (as I have done) a ship such as *HMS Foudroyant* and you will discover there is only one source. For some ships, the original builder's plans are available; for others you must rely on someone's reconstruction.

The point is that the plan for the ship you wish to build must be obtained. I think the procedure I outline here will even take a one page plan in a book and make it useful for building a model, I know it will work for a set of builder's plans.

I must leave it to you to find your basic plan. You will need the profile plan, the half breadth plan and the body plan. With these in hand your task then is to translate your paper plan into a wooden hull.

### Drafting

I remember reading books and magazine articles on how to draft out ship's frames from a plan. I thought I understood the theory of the process, but I also knew I lacked the skill and equipment. By the time I might have purchased a proper drafting table, a set of curves (actually, two sets), splines, a T-square, triangles, protractor, lettering sets, mylar and several thousand erasers, my personal budget would have been way overspent. I tried lofting frames with a ruler and a cheap compass. I quickly concluded I couldn't manage.

It has been said that there is no substitute for sitting at a table with pen and paper drawing out a ship's lines. I am inclined to agree, particularly if one is designing a hull from the keel up. On the other hand, the lore of the model ship is the call to a pleasant time of fulfilling creativity. I am under no illusion that I could ever design a ship. But I do want to be able to translate a set of ship's plans into a collection of keel and frames.

By now you know that I am no draftsman, nor would I dream of claiming to be. My training in the field is limited to high school geometry. For that matter, I should confess that I have no training in the

use of computers either. But if you will bear with me a little, I think we can come to a method of lofting out a ship's members from a set of plans that will be both accurate and rewarding.

## **Computers and Software**

A computer is a tool far more expensive than a proper setup of drafting equipment. But I have a computer for reasons other than ship model building. Since this instrument already sits on my desk, I do not count its cost as an expense of modeling.

The computer can aid me in drawing out my plans. In fact, software that does this is referred to as "Computer Aided Drawing" or "Computer Aided Drafting" or "Computer Aided Design." Thus, the "D" in CAD can have several meanings depending on exactly what you are doing. For my part, I am not designing a ship. I am drafting frames and drawing them out. The software I use is CAD, at any rate.

For many years, articles have been written on using computers in drafting and lofting frames. Almost always they have lost me at the cost of the software, normally in the thousands of dollars. Because I did not know any better, some years ago I purchased an inexpensive program that could draw lines and circles. I didn't know it at the time, but it was a simple CAD program. Later, I found an updated version of the same program, but now it had bells and whistles at every mouse click. It turns out to be sufficient for the process of lofting out frames.

In what follows, I have avoided reference to any particular software package. I have done so because I think the basic principles are more important than a step by step procedure based on only one CAD program. Moreover, no two people quite agree as to which CAD program is best. Much of it has to do with your purposes, what you are used to, and how much you want to spend.

While writing what follows, I obtained a very expensive industry level CAD program as a 30-day trial. It could draw rings around my little inexpensive program. I was gratified, though, to find that in my free 30 days I managed to draw out an entire set of lines for a ship. (It didn't take 30 days, just my spare time spread out over 30 days.) I have returned to my little program because I am used to it. I say this just to indicate that you do not have to spend a great deal of money for a CAD program that will get the job done. My inexpensive program cost me \$50, and can be found for less than \$20 if you look around. If you want to spend top dollar, go ahead. The method I describe will work just fine.

## **CAD Advantages**

Cost is just one appeal of using CAD for drawing out a set of plans.

Space is another. Drawing out plans on paper means drawing out plans on very large pieces of paper. There is a physical challenge just to keep everything in place. Moreover, I can carry my CAD work just about anywhere on a laptop computer. I find the work relaxing and so I found it enjoyable to draw out frames while at the beach. I suspect it would have been a bit more difficult to get all the pen and ink equipment to the seashore.

Time also enters in. With my files loaded on my computer, I have been able to spend the odd moment of time on my plans. My employment use of the computer is mostly word processing with just a tiny amount of spreadsheet work. It has been easy to splice in ten or fifteen minutes on my plans with just a mouse click to get in and out. In short, the computer lets you pay attention to your plans at your convenience and with a minimum of fuss.

Perhaps the biggest advantage to using CAD is that without the computer I simply would not do it. CAD lets me combine two things I enjoy in one endeavor. I don't think I would use pen and ink. If I am ever to produce my own drawings, it will have to be through the computer, and that means using CAD.

## **Some Background**

I cannot claim any originality to what follows. People have been drafting ship plans for centuries, and others have been using the computer to do so for decades. What I do claim is that the observations contained herein will produce an adequate representation of a ship. As with any set of human thoughts, there ought to be improvements made as time goes by.

The procedure I have used was developed while using plans for *HMS Foudroyant*, an 80 gun ship built in 1798. I used the original designer's plans and have been gratified to see the result in a set of frames resting on the keel.

But in writing out what I had done, I thought it best to repeat the process with a new set of plans. Almost on a whim I choose *HMS Boreas*, a smaller frigate of 28 guns launched in 1774. You will see references to both vessels, but most of the illustrations were created from *Boreas*. A few, it will be noted, are of *Foudroyant*.

Well, then, find your plans and lets begin. After a brief overview of what your paper plans contain, I will described how to get your plans into your computer, then how to fair them up, and finally how to loft out the frames.

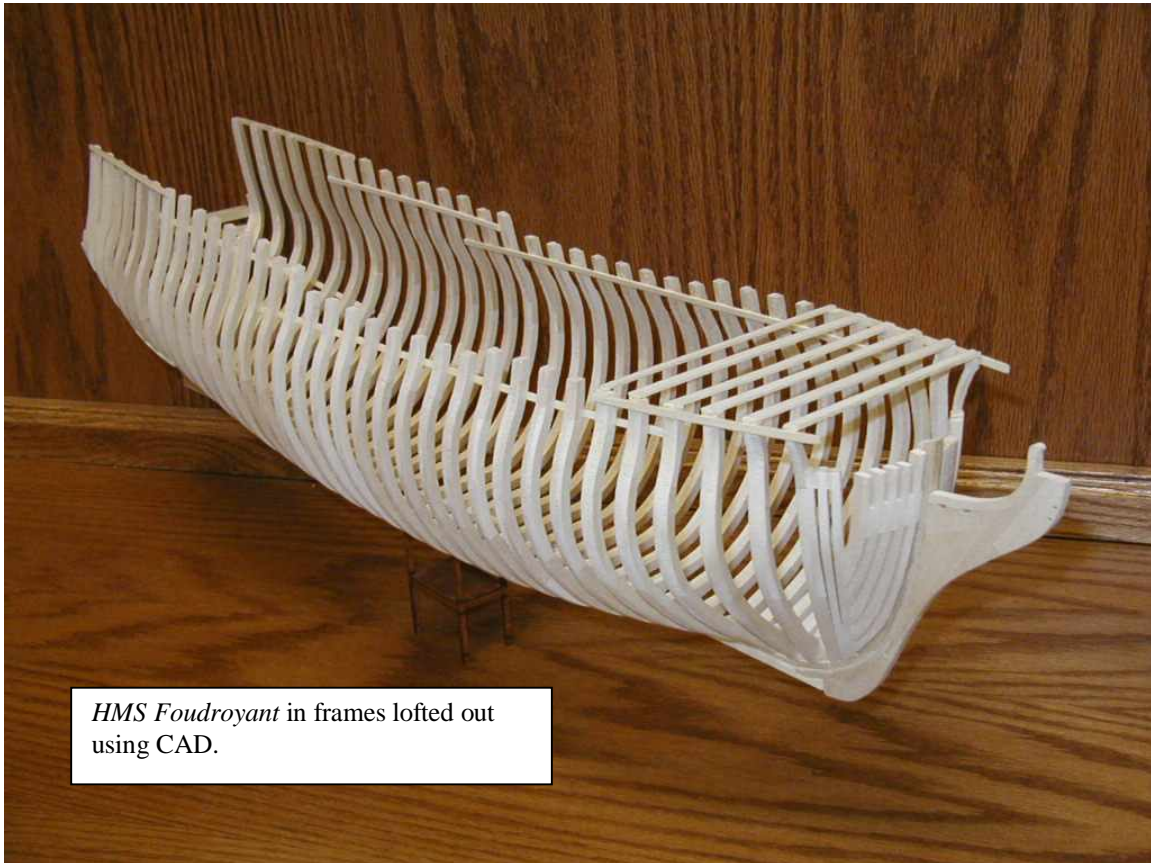

*HMS Foudroyant* in frames lofted out using CAD.

## Understanding the Plan

The lines of a ship are represented by three drawings on the plans. The side view of the ship is seen in the profile plan (also called the sheer plan). The top view is seen in the half-breadth plan (also called the waterlines plan). The end view is seen in the body plan. When taken together, these three views of the ship provide the information for producing the three dimensional form of the hull.

### Slicing the Loaf

A loaf of bread might help depict the relationship of the three drawings. I prefer French bread for this exercise. Anyway, suppose you want to put down on paper a set of drawings that would enable your shipwright (breadwright?) to reproduce the shape of the loaf of bread in a wood carving. You might draw a picture of the loaf and hope your compatriot could guess the shape from that. On the other hand, you are a finicky baker and insist that the new loaf look exactly like the original. Thus, you approach the problem from a mathematical point of view.

You begin by placing the loaf on a table. Then, from one side of the loaf, you draw out the exact side shape of the loaf resting on a line that represents the top of the table. This would be a profile of the loaf on paper and, since you do not have time to think of a better name, you call it the profile plan of the loaf. Your breadwright now can carve out this shape, but he knows nothing more about the final shape.

To help him out, you make slices in the loaf that are exactly one inch thick. Just so no one gets confused, you also draw vertical lines on the profile plan that are one inch apart to show where you cut the slices. For convenience you label them "slice 1," "slice 2" and so forth. Now you can trace the shape of the slices so your breadwright will know the shape of the loaf at each "slice line." As an efficient baker, you decide to put all the slice tracings on one drawing. You draw a line representing the table top and a line straight up from the table line to show the middle of the loaf. Now each slice tracing can be located, one on top of the other, to show the way the slices change shape from one slice to the other.

Unfortunately, however, the result is a jumbled mess of lines because there are so many slices. Being a clever fellow, you notice that each slice is perfectly symmetrical. This inspires you to put only half of each slice tracing on the drawing since the other half will be a mirror image. Now you find the biggest slice and use that as a reference. You decide to call this the "extreme slice" and you make sure to label it also on your profile drawing. The slices to the right of the extreme slice on the profile drawing you place on the right side of the slices drawing, and the slices to the left of the extreme slice on the left side.

Now your breadwright can figure out the shape of a slice and he will know also where that slice is located on the loaf. For some reason, you name the slice drawing the body plan, mostly because you think it would have pleased your high school geometry teacher. In deference to your need to be neat and tidy, you now place your body plan beside your profile plan and use just one straight line to represent the table top.

Slicing and tracing has been so much fun that you wonder what would happen if you sliced the loaf in a different direction and traced those new slices. So you glue your loaf back together (you are a really, really good chef and know how to do this) and then you slice the loaf with the knife blade parallel to the top of the table. Each slice is one inch thick. Again, just so you don't forget what you have done, you draw in lines on the profile plan parallel to the table line one inch apart where you made your slices. Each of these lines you label "table 1," "table 2" and so forth.

Once more you trace each of these table slices (so called because they were cut parallel to the table top) and put them all on a drawing. Astute fellow that you are, you again note the symmetry of the table slices so you know you only have to draw in half the slice (the other half being a mirror image). This drawing you could call a "tablelines" drawing, but because it shows just half the loaf and because each table slice shows the width (or breadth) of the loaf at any given points, you call it the half breadth drawing. You place it just under the profile drawing.

From these three drawings, the profile, the body and the half breadth, your breadwright can carve out a loaf exactly like the one with which you began.

Suppose, for the sake of argument, that we did not use a loaf of French bread. Instead we used a loaf of bread shaped precisely like a ship's hull. The profile plan would show the hull from a side perspective. The body plan indicates the outlines of the hull at designated places (called stations) along the length of the ship. And the half breadth plan portrays the shape of the hull at the water line and at other places parallel to the waterline (hence the alternate name of waterlines plan).

You might have noted that there is a third way to slice the loaf of bread. Once the loaf is put back together, you could slice it down its length with the blade of the knife held straight up and down rather than parallel to the table. Again make these slices an inch thick and mark their location on the profile plan.

Ah, there's the rub. These new slices cannot be indicated with straight lines marked an inch apart on the profile plan. They can be indicated as straight lines on the body plan and, for that matter, on the half breadth plan. On the profile plan, however, the new slices will show up as the tracings of the outer edges of the slices, that is, as a set of curved lines.

This leads to a key observation. Each of the three plans can show the shape of only one kind of slice. The profile plan can show a longitudinal slice, but the body and half breadth slices appear as straight lines. The body plan shows the station slices (our "normal" slices of bread) but the other slices appear only as straight lines. The half breadth plan can show us the slices parallel to the table top, but the other slices also appear only as straight lines. Moreover, the straight line slices on each plan create a grid very much similar to the old graph paper you may have used in school.

Now it is apparent that each of the three plans will consist of three kinds of lines (even as there are three kinds of slices). There will be vertical lines, horizontal lines, and a set of curved lines. The vertical and horizontal lines will indicate the placement of two kinds of slices, while the curved line will indicate the shape of one kind of slice.

There you have it. You have drawn up a set of plans for your loaf of bread that your breadwright can use to carve it out. A little butter and jam just might complete this pleasant endeavor.

### **A Cartesian Explanation**

A physical object such as a ship's hull can be described in a three dimensional system of coordinates. A piece of paper is in essence a two dimensional system. On a ship's plan, each of the lines drawings shows two dimensions as a grid upon which the third dimension is projected. As long as the three drawings retain a uniform point of reference, the plans can be used to infer the projection of any given dimension on the basis of the other two dimensions.

This is the essential nature of drafting and lofting out a ship's plans. Because the dimensions are orthogonal to one another, employing orthogonal lines of reference (construction lines) facilitates the projection of dimensions from one plan drawing to another.

In the above exercise, each kind of slice represented slicing through the three dimensional object along the axis of one dimension. So, let us assign the x-axis to the length aspect of the ship, the y-axis to the height aspect of the ship, and the z-axis to the breadth of the ship. Then the profile plan shows the x and y-axes, the body plan the y and z-axes, and the half breadth plan the z and x-axes. Simple logic shows that any two drawings will contain all three axes and, hence, be sufficient to construct the third drawing.

Now you know why I preferred using a loaf of bread to explain the drawings.

### **The Profile Plan**

So, let's roll out our ship's plans and examine the profile plan. This part of the drawing often contains a wealth of information for configuring the ship.

**The foundation** for both the ship and the ship's plans is the keel. If you were designing your own ship, you would begin by drawing a straight horizontal line on your piece of paper. This line would eventually become the keel and for that I reason I will refer to it as the keel line. (In point of fact, this line is the upper edge of the rabbet, the groove cut into the keel to receive the edge of the lowest plank of the hull.) It is from the keel line that all other lines in one way or another are drawn.

At the bow and stern you should find on your plan a straight vertical line. In that these are perpendicular to the keel line, they are called the forward and after perpendicular lines. The distance between these two lines is the length of the ship (more or less) for the purposes of design. This length is the "Length Between Perpendiculars" or LBP. Obviously, there is quite a bit of ship extending beyond the perpendiculars. The distance from the extreme end of the ship at the stern to the extreme end at the bow is the "Length OverAll" or LOA. In our work to produce a CAD drawing of our vessel, it is the length between the perpendiculars that will most concern us. There are a few other ways of talking about the length of a ship, but they also should not bog us down.

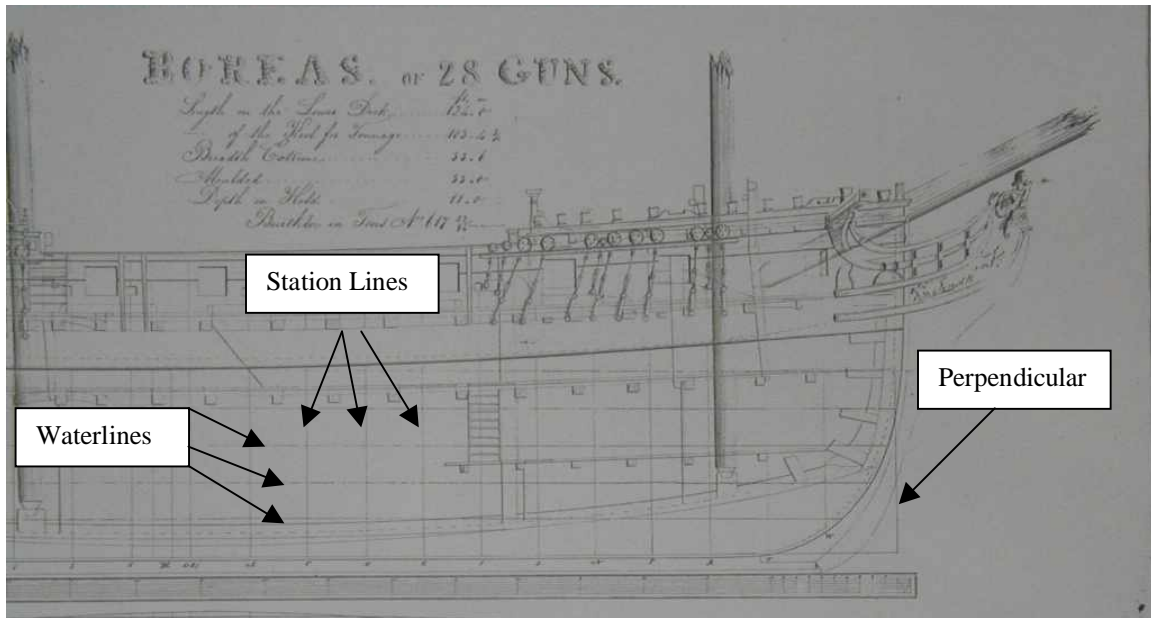

**The grid work of horizontal and vertical lines** depict the waterlines and the station lines. A slice through the hull of our ship that is made parallel to the surface of the water will show up as a horizontal line on the profile plan. For obvious reasons these are called waterlines. A vertical slice through the hull that is at right angles to the keel appear as vertical lines. These are called stations lines. Sometimes these stations correspond to the position of a ship's frame, sometimes they do not. It is best to maintain a distinction between station lines and frames since the former is a design reference and the latter is a physical member of the ship.

**Other information** on the profile plan should be intuitive. The location of various decks and furniture is often indicated. I must take it for granted that you will recognize what you see in this regard. If not, I suggest a quick look at some good reference books to orient yourself to the nature of a ship's interior.

**The buttock lines** may be seen on the profile plan. They are the lines that represent our third kind of slice through the loaf, the vertical slices parallel to the keel. If present, they are the curved lines laid out over the grid work of the water and station lines. We will not concern ourselves with the buttock lines until a bit later on. Hold your desire to use them off for just a bit.

### The Half Breadth Plan

You need to understand the half breadth plan as the lines resulting from drawing out the waterlines. Normally only half of the hull is depicted since the lines are symmetrical on either side of the center line. It is not uncommon for waterlines to run quite close to one another, particularly so at the mid-ship area. For this reason, some plans will place the lower waterlines on one side of the centerline and the upper waterlines on the other side. Study your plan to understand how the lines are laid out on your plan.

**The grid lines** on a half breadth plan will represent the station lines and the buttock lines. The station lines will run vertically at right angles to the centerline of the hull. The buttock lines will be horizontal lines running parallel to the keel. Again, we do not need to be overly concerned about buttock lines quite yet, they will come into play at a later stage in our drawing. In fact, the buttock lines can be omitted from the half breadth plan without ill effect, as is the case on a set of plans I am looking at now.

**The is one other kind of line** you might see on a half breadth plan. They are called diagonal lines. It is a matter of opinion, but I feel we can ignore them for our purposes in drawing out a plan in CAD. For the moment it is sufficient to say that they are used by shipwrights to yield a more accurate lofting of the frames. The accuracy of the computer obviates the use of diagonals and so I will ignore them.

Unfortunately, if they are on your half breadth plan they can muddy up the plan right quickly. Fortunately, we can skip using the half breadth plan altogether if we like, and as it turns out I will.

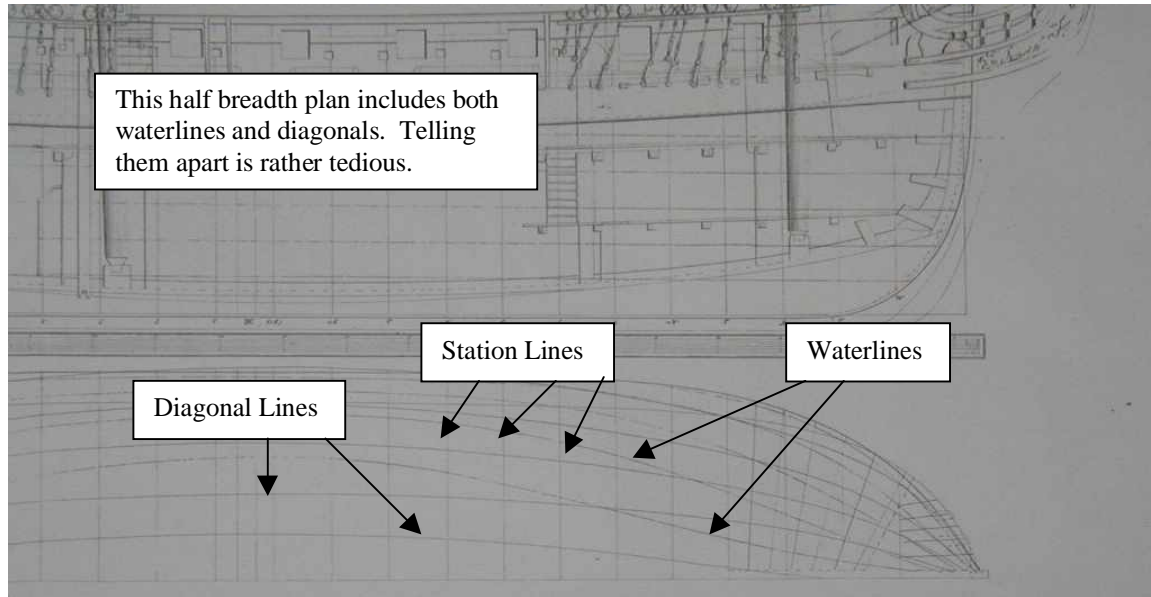

## The Body Plan

The body plan lets us view the shape of the hull as if viewed from the bow or stern. Often, the body plan is placed to the left of the profile plan with both drawings resting on a common keel line. This, by the way, will be our approach in this treatise. On the other hand, do not be surprised to find the body plan place in other locations.

**The keel** as always is the foundation for the drawing. You will recall that the keel line rests on the top of the rabbet, that groove cut into the keel to receive the edge of the lowest planking of the hull. The keel itself, of course, is a massive timber and on the drawing will appear in cross section on the body plan.

**On either side of the body plan** there may be a vertical line. These lines mark out the breadth of the ship at its widest part. There are two ways of expressing the breadth of the ship. One is to refer to the extreme breadth which is the width of the ship including the outer planking. This information is important if you every want to squeeze your completed ship through a canal. The other reference is to the moulded breadth and describes the width of the ship to the outside of the frames but with the planking removed. This information is more important to us as we loft out frames for our ship.

**The station lines** that were straight on the profile and half breadth plans are curved lines on the body plan. Many of the station lines begin at the keel line. Some station lines appear to intersect a line drawn up from the side of the keel cross section. This happens at the forward and after extremes of the hull.

**The waterlines** on the body plan may appear as a series of almost horizontal lines that are, in fact, very gentle curves. In our exercise with slicing bread we made our horizontal slices parallel to the table top and, therefore, parallel to one another. In point of fact, there are other ways to establish the waterlines on a ship that are not too confusing so much as a tad bit more ornate. For now, note the placement of the waterlines on your body plan, note that they are (more or less) horizontal, and console yourself with the knowledge that we will draw in our own waterlines when the time comes.



**Other lines** on the body plan are important for the shipwright, but not for our purposes. The diagonal lines appear as (you guessed it) diagonal lines on the body plan. Their purpose is to provide further points of reference to the shipwright in lofting out the framing. We will not need them for our CAD drawing. There may be a plethora of other lines on your body plan shaped like boxes with a sweeping alignment of corners. These are vital to the naval architect, but completely unnecessary for us. They were used to determine the sweep of the various segments of the hull during the design of the ship.

The placement of the wales is sometimes included on the body plan. Also, you may see some representation of the stern construction. Do your best to visualize the import of these lines since you may refer to them when building your model.

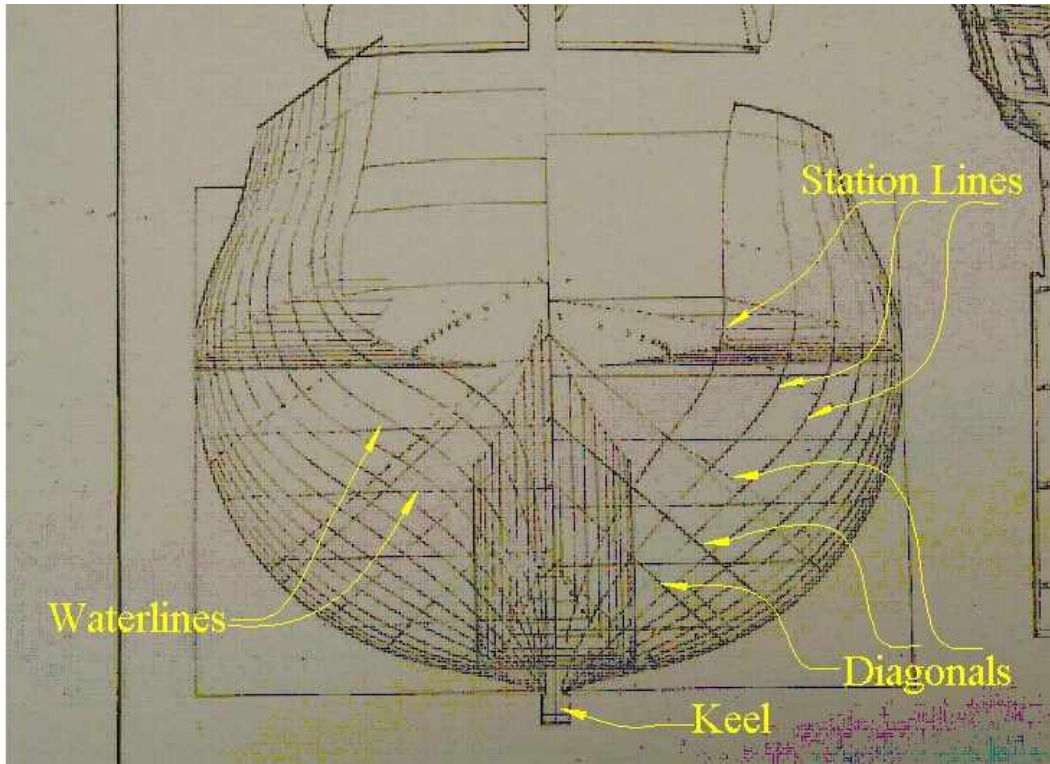

## Loading the Plan

Before we can use our plans in CAD, we must find a way for the computer to interact with them. I suppose some government agency has a super powerful computer that would accomplish this task automatically. I know there are tracing programs on the market that might simplify the task, but at what cost? On the other hand, and this is my choice, I can be the interface between computer and paper plans. In other words, I am going to trace my plans into the computer.

This requires loading an image of the paper plan into the computer in a format that CAD can recognize. This is not as esoteric as it first sounds. All we are going to do is take a photograph of the plans and create a computer file of the photograph. Many people have long become accustomed to putting pictures into their machines, so a lot of this will probably be old hat for you.

### Creating the File

**Scanners** can be found in many home computer systems. Your printer may have one included. If your plan is small enough to fit you could just scan the plan in. This may be the case if you are using a plan out of a book or if you have purchased a photograph of a plan (as you can from some museums). Once the scanned image is loaded into your computer, save it as a picture file for further manipulation.

On the other hand, you may have purchased a large sheet of plans far beyond the capacity of a home scanner. In this case you may let a professional shop supply you with an image file. A far more attractive alternative is to use a digital camera. If you don't have a digital camera, chances are that you have a friend who does. If you do not have any friends I can't help you. Go buy one (a camera, not a friend).

**A digital camera** produces a computer usable image. Along with the camera will come the appropriate cables and software to put the image into your computer. The more difficult thing to do is to take a picture of your plan that you can load onto the drawing area of your CAD program. My camera, for example, will produce pictures in both a JPG and TIFF format. If these letters mean nothing to you, don't let that stop you. Just think of them as different languages like Spanish or German. In the end, we need a language that is also spoken by your CAD program. There are a number of picture languages, but the more common are JPG's, TIFF's, GIF's and BMP's. The better CAD programs will read these and a host of others as well. My little CAD can't do better than understand BMP's and I have had no problem in loading plans in. I am using the assumption that, if my inexpensive little system can do it, so can yours.

Just so you don't worry, your computer probably has an image program in it that allows you to look at pictures. It may be an expensive photographic manipulation program, or it may be the simple drawing program that came out of the box with your machine. In that program you will most likely find a "Save As" option for saving the picture you are looking at. Under that option you can choose the format (picture language) you want. Thus, if I load a JPG into my machine and look at it, I can then save it as a BMP image. It's kind of like translating the image from German into English. My CAD speaks English (can recognize BMP images) so it is happy. This is really so basic I almost did not mention it.

So, just take a picture of your plan and load it into the computer. I wish it were that simple.

**Taking the picture** turns out to be a bit of a challenge. If you are taking a picture of a small plan (such as I have done out of a book), then you just point and shoot. The original plan in my case was no bigger than a few inches long so the camera was able to produce a serviceable photograph without any problems. The down side of this, however, is that the original plan is so small that important details may be missing. Also, when relying on a small plan the accuracy of the plan may be questionable. (In my case, the plan had some atrocious problems in it.)

Still, if you are using a small plan, I might make a suggestion about what you point at before shooting. Remember that there are three basic plans for a ship: the profile, the half breadth and the body plan. Each of these can be traced separately. For this reason, each of these three can be photographed separately. We will combine them later on. The profile and half breadth plans are such that they can be included in one photograph with good results. However, by photographing the body plan separately you end up with a better close up of the plan. You have no idea how thankful you will be for this increased accuracy during the tracing process.

It is more likely that your plans are in a larger scale. At 1:48 scale, a ship's plans can exceed four feet in length. Placing this entire length on one photograph creates something of a problem.

First, there is the physical problem of taking the picture. You could have four children hold the plan up while you step back in order to take the picture (something I have not tried and would not recommend). Or you could tape the plan to a wall and back up until you could get the whole plan in the picture (something I have tried with middling results). Or you could lay the plan out on the floor and take the picture from an elevated position, such as on a step ladder (something I have tried with better results). If you can get high enough to be far enough away from the plan, you might get the whole plan onto one photograph. But this generates the second problem.

If you take a picture of a straight line, you will notice that the photograph actually shows the line as having a slight curve to it. This results from the curvature of the lens. A photograph of a ship's plan will show a curved keel that should be straight. When reducing a large paper plan to a photograph, this distortion can be quite annoying if not downright disastrous. No doubt, NASA has a computer that can compensate for this, but I don't. I had to find a way around this problem.

My answer was to photograph the plan in two or three sections. I could then move in closer to each section than I could if I tried to take the whole plan at once. Also, the distortion as a percentage of the dimensions of the plan is lessened. For this reason, I took one picture of the bow, one amidships, and one at the stern. I did this for both the profile and half breadth plan resulting in six photographs. The body plan was taken in just one photograph. In the end I had seven photographs to cover a plan that was about six feet long and two feet wide. On a smaller vessel I used just two photographs for the profile plan. If you choose to follow this method, make sure your photographs have some overlap to them so they can be rejoined later on.

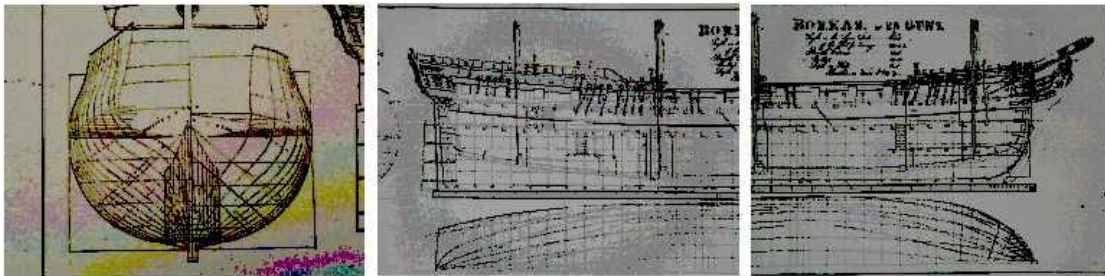

**HMS Boreas – Photographed in three sections for clarity.**

For readers who might wonder why I suggest putting distance between the camera and the plan, let me say that I am only trying to save you some frustration. When I photographed my paper plans from a few feet away I ran into a severe distortion problem. With the plans on the tabletop, I stood over the plan and snapped away. The resulting images were so distorted as to be frightening. This is why I suggested placing the plan on the floor and moving to a raised position. The extra distance between the lens and plan lessened the curvature of straight lines on the image. My camera has a zoom feature (which I should think is very common to digital cameras) that allowed me to take a close up picture from this increased distance. The images showed minimal distortion as a result.

Some people have more sophisticated photography programs in their computers. For them it might be fun to stitch the seven photographs back into one. I have neither the programs nor the inclination to do so. Looking ahead, I will suggest that the sections of the plan be rejoined after they have been traced. Your CAD program will take care of this little detail without any trouble.

For the record, when I refer to the “photograph” or “picture” in the singular, it may be that we are including a series of photographs in the process.

### **Loading the Photograph**

Now we need to get the photograph from the camera into the computer and then onto the CAD drawing area.

**Putting the photograph into your computer** is a matter of following the directions that accompany the digital camera. Once you have put the picture file in, the next step is to save it in a format your CAD program will understand.

I suspect your CAD has a menu option called "Insert" that allows you to place a picture file onto your drawing area. Read your documentation or help topics to see what formats are accepted by your CAD program. For example, most cameras will take JPG pictures and many CAD programs will also accept them. My smaller CAD won't, so I convert my JPG pictures to BMP pictures that can be read by my CAD. My understanding is that BMP files are about as poor a choice as possible for this kind of work. I don't know about that. I do know that BMP pictures work just fine for me.

There are several kinds of BMP (bitmap) formats, at least four that I know of. I had to experiment with them to find the one that worked best on my computer. For me it was a 24-bit bitmap. I'm sure you can determine which picture format you need for your CAD program. Just keep experimenting until you get a good image on your drawing area.

The goal is to have a picture (or pictures) on the drawing area of your computer. How you get to that point will depend in some part on the particular hardware (camera, scanner) and software (CAD, imaging program) that you have.

**The basic steps**, then, are: a) photograph your paper plan, b) load the picture into your computer, and c) be sure you save the picture files in a format your CAD can use (by either selecting that format in the camera or by converting it inside the computer).

Once you have your plan in an appropriate format, open your CAD program and create a new drawing. Insert your photograph into the drawing area. If you have chosen to use multiple photographs, load them all in. The entirety of your profile, half breadth and body plans must be visible on your drawing area.

You may want to take a few minutes zooming in and out on these photographs. My little CAD allows me to zoom in on a photograph about 400% before turning a blank gray. A later version of the same program allows about a 2000% zoom. Yet another CAD program allows me to zoom in to my heart's content. Really, though, after a few thousand times of magnification there is not much to see. As far as I can tell a 400% enlargement is quite adequate for the task at hand. Different picture formats will behave differently, but whenever a line is enlarged (you zoom in) the line will become a fuzzy blur after a while at any rate. I say this to point out that even an inexpensive program will get the job done.

**Your plan is now ready** for tracing. If you have a powerful, professional grade CAD program, you just might have an automatic tracing capability. But why loose out on all the fun? More to the point, tracing your plan in CAD will put the information contained in the plan into your computer and, frankly, I don't think I would entirely trust a tracing program to do the job. Besides, if you have a tracing program and know how to use it you probably have enough expertise to produce your plans without this little missive anyway.

## **Looking Ahead**

The observations about tracing that follow are based on having just one photograph for each of the three ship plans. When using two or three photographs for the profile and half breadth plans, some adjustment to the process must be made. Each plan section can be traced following the general guidelines I suggest. After the tracing is finished we will join the sections together in the CAD drawing area.

I know having the photograph separated out like this might make some people uneasy. But to address a possible concern, CAD will allow us to put the sections together by scaling them to the same scale and then attaching them at a common index point. I'll describe the steps in this process after tracing the plan photograph.

## Tracing the Plan

With the paper plans loaded into the drawing area, the lines on the plan can now be traced. After this tracing, the underlying plan picture will be removed, thus leaving a drawing that can be manipulated into its final form. We start with the profile plan.

Here is a good spot to think about the basic technique of tracing with CAD. Your plan is loaded into the computer as a photograph and, for that reason, will have a limited degree of resolution. Whether high or low, your plan will eventually turn into a collection of fuzzy patches as you zoom in. In actuality, the lines on your plan are a few hundredths of an inch thick. In traditional drafting, the human eye would accept a pencil or pin prick anywhere within the width of the line. Thus, a traditional draftsman isn't too exercised about where he traces the line as long as he is in that width called the line. For CAD purposes, the lines you draw with the computer have no width at all. That is why your CAD line remains razor thin no matter how far you zoom in on it or, for that matter, how much you zoom out. As you trace the plan, your new lines should fall inside the width of your plan line. Just sight the CAD line in the approximate middle of the photographed line (which is a wider blur after zooming in) and trust that you are probably more accurate at this point than any manual draftsman could be anyway

### The Profile Plan

It is important to know which lines are significant for tracing. Of course, all lines related to the keel, stem and stern must be traced. Also, the cap rail must be traced since that is the line that gives basic definition to the height of the frames. The lines of the wales will be helpful as will the deck lines. The headwork adds to the overall effect of the drawing as do the stern and quarter galleries. Gun ports and other apertures (entry ways, oar ports, ballast ports) should be represented. The perpendiculars forward and aft are vital to giving the drawing its proper dimension.

Your drawing may not have all the elements mentioned above, but whatever information your plan offers, trace it onto the drawing. You can erase unnecessary lines later, but it will be difficult to add a line from the paper plan once the photograph is removed. So, when in doubt about a line at this point, trace it. The exceptions to this rule, oddly enough, are the waterlines and the buttock lines. We will draw them in for ourselves.

**Begin with the keel.** The first line to trace is the top of the rabbet. This will become the foundational reference line for everything you do from here on. On most plans, the top of the rabbet runs along the top of the keel. (On some ships, the top of the rabbet is set below the top of the keel, but since the frames will align with the rabbet, this is the more important line to trace.) Use the line tool to trace the keel line. Begin at the forward end and click on the line. Usually, this line extends beyond the keel at the forward end. If so, click on the forward most end of the line. Stretch the CAD line to the after end of the ship to where the keel line terminates and click again.

At this point it may be interesting to examine the middle of the line you have just drawn. If you have used a camera to photograph your plan for insertion into CAD, you may see that your new line fails to lie on top of the keel line at this mid-point. This is caused by the curvature of the camera lens, resulting in the photographed line actually being somewhat curved. This is nothing to worry about since you will end up using the CAD line, which is perfectly straight. If you scanned your plan into your computer, you probably will not see this distortion.

(A more expensive CAD program will allow you to rotate your image. There is some advantage to making the keel line you just drew level (horizontal) with the drawing area. If your program allows you to rotate an image, read ahead on leveling the drawing and do so now before adding any other lines. This simply permits you to use certain orthogonal tools in lieu of perpendicular tools. The outcome is the same whether you level the drawing now or later, however.)

With the top rabbet line traced, note how it is intersected on your plan by a curved line at the stem. This is the continuation of the rabbet and should also be traced. There may be something of a double line on your paper plan. It is the inside line that we want to trace.

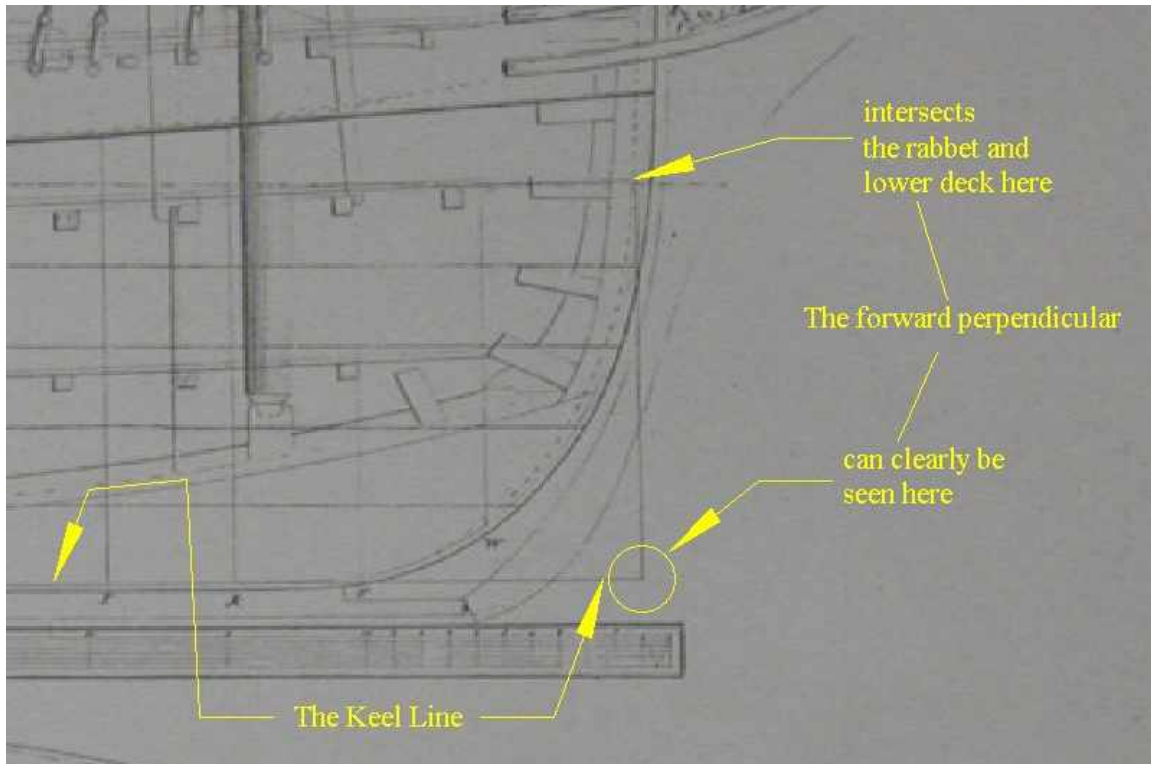

**HMS Boreas – Establishing the Keel and Perpendicular Lines.**

For this you will use a spline. Make sure you use the spline feature in your CAD program in which the curve passes through the control points you set down. This is called a Bezier and is a special case of splines in general. (Other possibilities are curves that are “attracted” to the control point but do not pass through them. The distance from the curve to the control point can be altered, in effect. A Bezier is the special case where the distance between the control points and the curve is zero.) Your CAD program may use varying terminology, but you must use the spline curve that passes through the control points. Understand that when I use the term “spline” I am actually referencing a specific kind of spline, a Bezier.

Beginning at the point of intersection, initiate the spline on the rabbet line. Be sure the spline curve begins on this keel line. Then continue setting points along the curve until it terminates just below the top of the stem piece. Again, zoom in as much as possible on your plan photograph and place the points in the middle of the resulting blurred line. Eventually you will want the entire rabbet at the stem drawn in, but for now the after part of the rabbet is the more important line to trace.

At the stern, trace the position of the stern post. While the entire sternpost may not be indicated on the profile plan, the after part will be clear. Another line to include is the line that represents the junction of the planking and the sternpost. In effect, this is similar to the rabbet line in that it defines the disposition of the planking. The line tool is used for these tracings. Be sure these lines rest on the keel line.

To complete the keel, trace the bottom line of the keel. Place the starting point in at the after end and stretch the line to the forward part of the keel. At the very bottom of the keel you should see yet another line representing the false keel. Trace this line in as well using the line tool. Now, using the spline tool, trace the bow of the ship. You will follow a graceful curve on the old men-of-war ships. Do your best to include as much as you can. At the forefoot of the ship you may see a collection of lines representing the boxing joint of the keel and stempost. Trace these in for future guidance in sketching out this joint. The line tool is best for tracing the boxing joint.

By now you are noticing how the spline tool is very useful to trace curves. Where the line you are tracing is gently curved, just a few points will define the curve pretty well. Where the curve is more severe, you will find it necessary to use a good number of points. Just keep an eye on the resulting curve as you place your points.

**Trace the cap rail** while you are tracing the profile. Eventually, each frame will come up to the bottom of the cap rail. When tracing the rail, you will want to use the spline tool since the rail is not a straight line but a gentle curve. In places where the rail has a more acute curve to it, simply be sure to use more location points. The entire rail cannot be done in one curve since there are junctions of 90 degrees (at the waist, for example). At these places, end the one line, and begin a new line with a beginning point at the end of the previous line.

The cap rail is, as its name implies, the rail that caps off the frames. There may be a higher open rail above the cap rail. Trace it too, if you like, but remember that it is the cap rail that defines the height of frames. Well, sort of. In actual practice some of the frames extended above the cap rail with the timber heads forming strong attachment points for rigging. This is very often the case at the forecastle. If you plan to go to all the trouble of building your cap rail around these timber heads, then you must indicate them on your tracing. On a model, it may serve the notion of a relaxation rather than a chore if you add faux timber heads after installing the cap rail. The choice is yours.

With the cap rail traced, now outline the stern profile. If nothing else, this will make your drawing more appealing. For the same reason you may want to trace all the head work on your drawing as well. Again, the basic maxim at this point is this: when in doubt, trace it.

Remember, at this point you are basically loading information into your CAD program for later use. The draftsman of old would have taken measurements off the plan and listed them all on paper. Such a "Table of Offsets" is confusing enough to read today and, most likely, too confusing to create for the recreational model builder.

One of the great advantages of CAD is the ability to use color. As you might imagine, the final plans will have a myriad of lines running next to each other, crossing one another, and then crossing back. If you have looked at a half breadth plan that has a dozen waterlines or so, you have seen how difficult it can be to follow an individual line. As we develop the drawing in CAD, we can choose different colors for the various lines, thus making identification easier.

Tracing the lines into your computer fixes the data on your plans in your machine in a visual form. You may, or even may not, use the information later to produce your final drawing. But if you omit information at the tracing stage, you will find it difficult to extract the information from the plan for your CAD drawing later on. Once the tracing is lifted off the photograph, transferring information from the paper plan to the CAD drawing will require measurements with dividers and keyboard data entry. This is not as fearsome as it may sound, for I have done it without great heartache. But now is the time for getting all the information possible off the paper plan through tracing.

**Now for the deck lines and wales.** The upper and lower lines of the wales should be clear on your plans and thus are easily traced using the spline tool. Just a few points for the spline should be needed since the wales follow a long and graceful sweep.

Your plan may have the level of the decks indicated by a dotted line or by a series of either two or three lines. In the latter case, the upper deck line is the height of the deck amidships and the lower line is the height of the deck at the side of the hull. Trace both lines, again with the spline tool. Be sure to follow these deck lines all the way to the rabbet lines you traced earlier at both the bow and the stern. As a result, you have the decks marked on your tracing.

The gun ports can be traced at this point. Using the polyline tool, each port is outlined. Later, you will either set the final height of the deck in relationship to the height of the ports, or you will set the height of the ports in relationship to the height of the deck. For now, include both on your tracing.

**The all important perpendiculars are next.** Two lines must now be drawn just as carefully as possible. The forward perpendicular is a line rising at a right angle from the keel line (the top rabbet line in our case) and passing through the intersection of the deck and the inside rabbet line at the bow. The after perpendicular rises from the keel line at a right angle and intersects the junction of the deck and inside rabbet line on the stern post. Which deck? Well, that all depends on how long you want to argue the issue. On your paper plan, however, you should see just such a line. Depending on the ship, the deck intersected by the perpendicular may be the lower deck (with or without guns), the gun deck (with another full deck below), or the lower gun deck (on the larger ships of the line). The good news is that you don't have to figure that out. Just reproduce the perpendiculars as they appear on your plan.

Also, look at how the length of the ship is described on your plan. Common descriptions are “Length of the gun deck,” “Length the lower deck” and just plan “Length.” Where a specific deck is named you will find the plan’s perpendiculars intersecting that deck and the rabbet line.

To draw your perpendiculars, you may need to extend the keel line beyond the forward part of the ship. For now, just extend the line out until it extends beyond the forward part of the ship. Actually, your paper plan should have this keel line extended anyway, and if you traced it for its full length, this step of extending the keel line may not have been necessary.

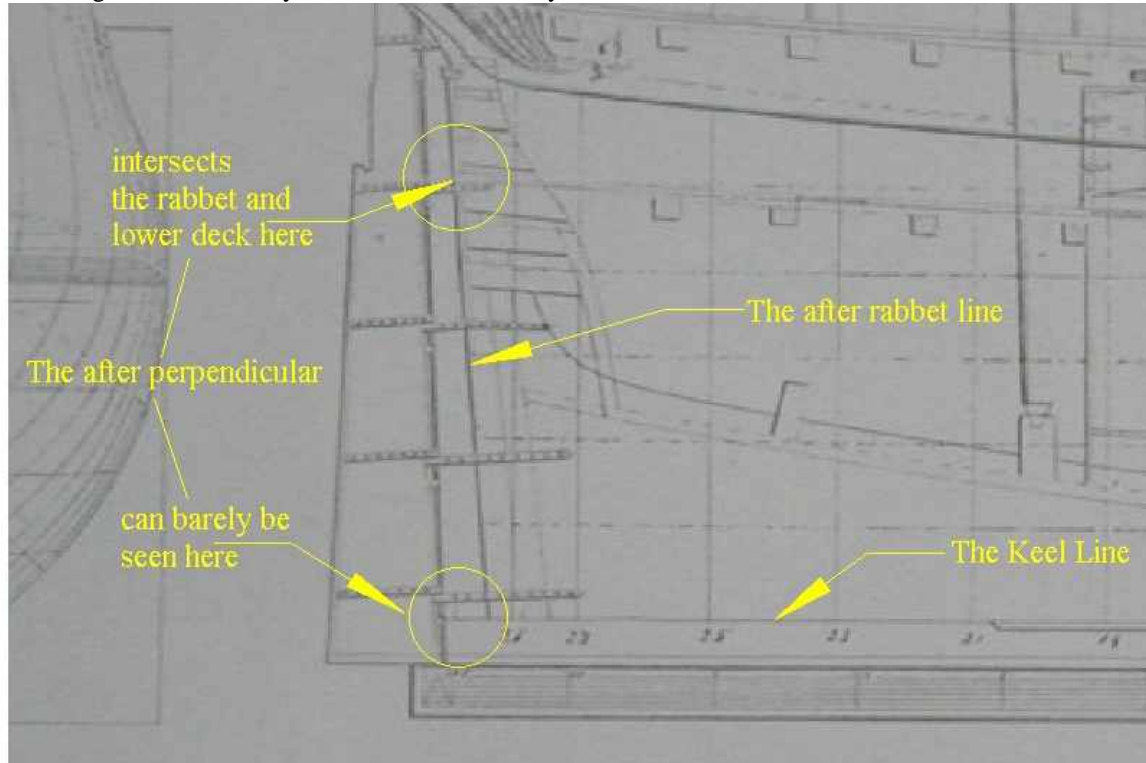

**HMS Boreas – Finding the After Perpendicular Line.**

The perpendiculars are the first lines you will draw that do not trace the existing plan. The reason is simple; the perpendiculars on your paper plan are not perpendicular. This is not from lack of trying. Plans deform over time as paper submits to the dynamics of the environment. Moreover, the plan is itself subject to a certain degree of human error (which, thankfully, is greatly reduced by CAD). Thus, we will use the plan’s perpendicular to show us where our perpendicular should intersect the deck and rabbet. But we will not be concerned about setting our perpendicular exactly on top of the plan’s line. But don’t be misled. The accurate placement of the perpendiculars will determine how well you end up with a well scaled drawing.

Now, to draw in the forward perpendicular line, we are going to use the (surprise!) perpendicular features of CAD. One of my CAD programs has a perpendicular line tool. The other program accomplishes the same goal with a straight line and a perpendicular snap mode. Your CAD program may vary, but the process will look a lot like what follows. With the appropriate settings selected, click next to the keel line. You will notice that a line now extends from the keel line to the cursor. As you move the mouse the line will travel left and right with its length stretching to match the position of the cursor. This is, I think, fun to watch, but there’s more to do. Now, zoom in just as much as you possibly can to the part of your plan where the appropriate deck and the rabbet intersect at the bow. You should see the paper plan’s perpendicular line also passing through this point. Just as accurately as you can, place the cursor on top of the intersection and click. If you zoom out at this point, which I recommend, you will see the perpendicular line no longer travels right or left, but will still stretch its length to the cursor’s height. You have just fixed the perpendicular so it is at the proper place vis-à-vis the keel line. Extend the line’s height to a point well above the ship and click again. You have just drawn the forward perpendicular.



Do your best to become adept at zooming in and out of your drawing. This can be done from the pull down menus, but a wheel mouse is much more efficient. With a little practice you will be zooming in on your drawing so that nothing but a couple of lines shows on the drawing area. The next moment you will have backed out to take in the entire drawing, thereby giving a sense of vertigo to the person watching over your shoulder. This is one great advantage of CAD and will be even more useful as we proceed into lofting out frames.

The after perpendicular is drawn in exactly the same manner at the stern. The only difference is that you may not have to extend the keel line. Again, be sure to extend the after perpendicular to a point well above the ship.

**The station lines** indicate the position of the body plan profiles along the keel. They appear on your profile plan as straight vertical lines. They should be evenly spaced along the length of the hull with, perhaps, an extra station at the bow and stern for added definition. Without the station lines it will be virtually impossible to reproduce the shape of the hull accurately. For this reason, we want to trace them in.

On many ships, the stations are perpendicular to the keel. If that is the case for your ship, trace them in a manner similar to what you used for the forward and after perpendiculars with the keel line as the base reference line. It is highly unlikely that on your paper plans the station line is at a perfect right angle to your traced keel line. For now, set the position of the perpendicular station line by clicking on the station line at a spot about half way up. Then stretch the line to a point just above the cap rail (sheer line). This will give you a station line that approximates the paper plan. You can repeat this process for each station line and then you will have a serviceable set of lines.

If your ship sets deep at the stern and is so indicated by the plan, you should simply trace the stations with the line tool. As long as you are reasonably close in your tracing you will end up in good shape for fairing the body plan with the half breadth plan later on. For our purposes, however, I assume that the keel line on the paper plan is level and that the station lines are at a right angle to the keel line.

The important thing to keep in mind is that each station line will have a matching station line on the body plan. To the extent that you set your traced station lines at the correct place, the process of fairing the body and half breadth plans later on will be easier.

**How accurate do you have to be?** Well, remember that these things have been done for hundreds of years with pen, ink and paper. The tools of drafting in themselves invite a certain amount of variance. The mutability of paper adds another dimension of error. Plus, nobody I know is perfect. In CAD you are probably going to be within a few hundredths of an inch of the line you are tracing. Believe it or not, that is going to be close enough for producing an accurate model

**The buttock lines**, if they appear on your plan, will not be traced. We will insert buttock lines at a later time in our final drawing since they help define the lowest part of the underwater shape of the hull. Tracing them now, however, will not add sufficient information to merit their inclusion.

**As for the waterlines**, I debated whether to add them in at this point or to wait until later. In the end I think we can draw the waterlines in later since our approach to the question of waterlines will be somewhat different from that of a ship's architect. On your original plan the waterlines can be drawn in with several different approaches. For example, if you take a glance at the body plan you may see the waterlines (the near horizontal lines) as slight curves rather than as straight lines. (This happens because a ship often sits deeper in the water at the stern.) I want to have evenly spaced straight waterlines that are parallel to the keel line. This won't necessarily happen if I trace the waterlines onto the profile plan now.

Our waterlines can be added later, as you can tell, because their placement relates directly to the keel line. At any time we could add a series of parallel lines (to the keel) to create our waterlines. Eventually, the profile plan will need waterlines and, when we insert them, we will mimic the spacing on our original plan. This comes later, however, so we can move ahead without further ado.

**At this point**, you have traced just about the entire profile plan. Among other things, you have established the line of the keel and have drawn the forward and after perpendiculars. The half-breadth plan awaits.

## The Half Breadth Plan

In point of fact, we can probably skip tracing the half breadth plan at this time. Later on, we will draw in new waterlines based on the body plan. If you like, you can go directly to tracing the body plan without ill effect. However, keep in mind that the half breadth plan is lurking in the background. During the fairing process we will construct our own half breadth plan. It will be important at that time that we have a good imitation of your paper plan. If you do choose to trace the waterlines, you will have gained a good first hand understanding of the shape of your hull in the horizontal plane. You will also have a visible point of reference with which to compare your own waterlines. I'm not sure it is worth the effort since you can make that kind of judgment directly by comparing the paper plan to your drawing. The choice is yours, but I want you to know that the following suggestions on tracing the half breadth plan may, in the end, be somewhat superfluous.

The half breadth plan requires the same approach as the profile plan. We establish the position of the keel and then trace just about everything in sight. Whereas the profile plan includes much detail beyond that needed for framing the ship, the half breadth plan contains the waterlines, each of which tells an important story about the shape of the hull.

Some plans have only a few waterlines depicted. Other plans have so many that the lines cannot be untangled from one another. This is where the zoom feature of CAD gives us the advantage of a powerful magnifying glass. Especially for us who have astigmatism, we may still find it virtually impossible to follow just one line through a jungle of other lines. Not to worry, just do the best you can since the traced lines will be brought into proper alignment later on during the fairing process.

**A word of caution** may be needed here. A half breadth plan sometimes also contains diagonal lines. A diagonal line on the half breadth plan looks very much like a waterline, but the two are not the same and must never be confused. The placement of the diagonal lines may be on a side of the plan opposite the waterlines. Or, diagonals may be superimposed on the waterlines. Some plans do not indicate diagonals at all. Unfortunately, right now I am looking at a plan that has the diagonals drawn in on top of the waterlines. It is all very confusing but not totally undecipherable.

The good news is that we will end up drawing all new water lines anyway when we fair up the plans. Tracing the half breadth plan gives us a general guideline for our own waterlines. In fact, we probably could skip this part of tracing as long as we had a keel line and the perpendiculars.

**Establish the keel.** The straight lines representing the keel are traced just in the same way as on the profile plan. Your plan may show just one line for the keel. If so, this line represents the center of the keel. The waterlines will terminate off this one line at a distance representing the side of the keel. Sometimes, the side of the keel is drawn in, especially at the bow and stern where the waterlines intersect the keel. At the bow, the keel may have an even broader siding. This represents the manner in which the stem widened at its head in order to join with the hawser pieces. Don't worry about this right now, just trace the waterlines to the spot where they end (usually forming a "notch" at the bow and sometimes at the stern as well; this notch represents the rabbet).

The important thing is to have a straight line that lines up with the keel. Using the line tool, click on the after end of the keel line. Then run the cursor to the forward end of the keel and click. You now have a straight line in the computer, even if photography has distorted or curved the line on your paper plan. This line is the centerline of the ship.

If your plan included lines indicating the side of the keel, they can be traced in using the line tool. This falls under the notion of having too much rather than too little information on your drawing.

**Trace the waterlines.** Each of the waterlines should now be traced using the spline tool. Again, the location points should be placed by sight in the middle of the paper plan's lines. There is no need for great consternation here. Essentially, these waterlines will be used primarily for reference purposes. The beginning and ending points should connect to the side of the keel (if represented). The intervening points are placed on the paper plan's line.

These traced waterlines will be used as a guide for judging the final waterlines on our drawing. If the original waterlines on your paper plan are parallel to the keel, there will be a close correspondence between the traced and final lines. On the other hand, if the original waterlines are not parallel to the keel

(which is what causes them to appear as slight curves on the body plan), then your final lines will mimic the traced lines, but will not match them exactly.

The half breadth plan is really nothing but waterlines. Trace away, and in so doing you will start to get a feel for the way the hull would have slipped through the water. Just be advised that your tracings will not belong in existence.

**The perpendiculars** may or may not extend to your plan's half breadth plan. If your plan does show the perpendiculars here, they will guide you. If your plan lacks them for the half breadth plan, you will simply have to work around this little omission later on.

If you have them, draw in the forward and after perpendiculars in the same manner as you did for the profile plan. Using the perpendicular tool, click on the keel center line. Then click on the spot where the paper plan's perpendicular intersects the keel (which may also be on the center line). Then, extend this perpendicular line to a spot beyond the widest water line. Do this forward and aft and you will have completed tracing the half breadth plan.

**You have completed** tracing the profile and half breadth plans. It should have been a pleasant few hours getting to know your ship. We are more than half done with the tracing process and, by now, you should feel pretty good about your skill in tracing a lines. If, as I did, you gave in to the temptation to skip the half breadth plan you have avoided a bit of extra work.

## The Body Plan

The lines on the body plan show the shape of the hull cut across the keel like slices of bread on a loaf. The body lines will define much of the shape of the hull. We will also use the traced lines of the body plan to create our own waterlines on the half breadth plan. For this reason, it is important to be as precise as possible.

Each station line on the body plan should be matched on your paper plan with a station line. There are various ways in which the profile station lines are indicated with numbers, letters, or a combination thereof. For simplicity's sake, use the system found on your plan. This will make cross referencing between your CAD drawing and the paper plan a lot easier as you go along.

**The keel lines** are set down first of all. You will remember that we used the top of the rabbet as our basic keel line when tracing the profile plan. We will duplicate that procedure now.

But first, we need to establish the midline of the plan. This should be indicated on your paper plan as a vertical line in the middle of the body plan. Interestingly, midlines tend to be in the middle of things. Anyway, trace the midline with the line tool. By now you have become adept at tracing lines from your plan so tracing the midline here should be a matter of course.

Now, we need to create a line that is perpendicular to the midline and that rests on the top of the rabbet. This line may be on your paper plan, but you don't exactly want to trace it. The lines on your paper plan are seldom perfectly true to a right angle. Also, the process of loading the plan into your computer has encountered so many opportunities for distortion (however slight) that you will want to rely on the computer's unerring ability to draw perpendicular lines.

Using the appropriate settings for drawing a perpendicular line, click on the midline. To set the proper position of the new line, click on a point even with the top of the rabbet determined by your paper plan. If there is a line on the paper plan, use the point where the paper plan's horizontal line intersects your midline. After clicking on this point, extend the line to a point beyond the widest part of the body plan. In a perfect universe, your new line should set on top of the line on your paper plan. In reality you will be slightly off. Don't be too concerned about that for the present.

This second line represents the height of the rabbet. This line corresponds to the keel line you drew first of all on the profile plan. For this reason, I will refer to it as the keel line. It must now be extended to the other side of the body plan. Your CAD program will have a method for extending the length of a line. It may be "Line Length" or "Line Extend," which makes consulting your help topics a useful thing to do.

At the bottom of the body plan you should see a rectangular shape depicting the keel in cross section. We need to trace the sides of the keel, but only by half. It is important that the width of the keel

on your CAD plan is equidistant on either side of the keel midline. To accomplish this, we construct a line parallel to the midline that rests on top of the side of the keel.

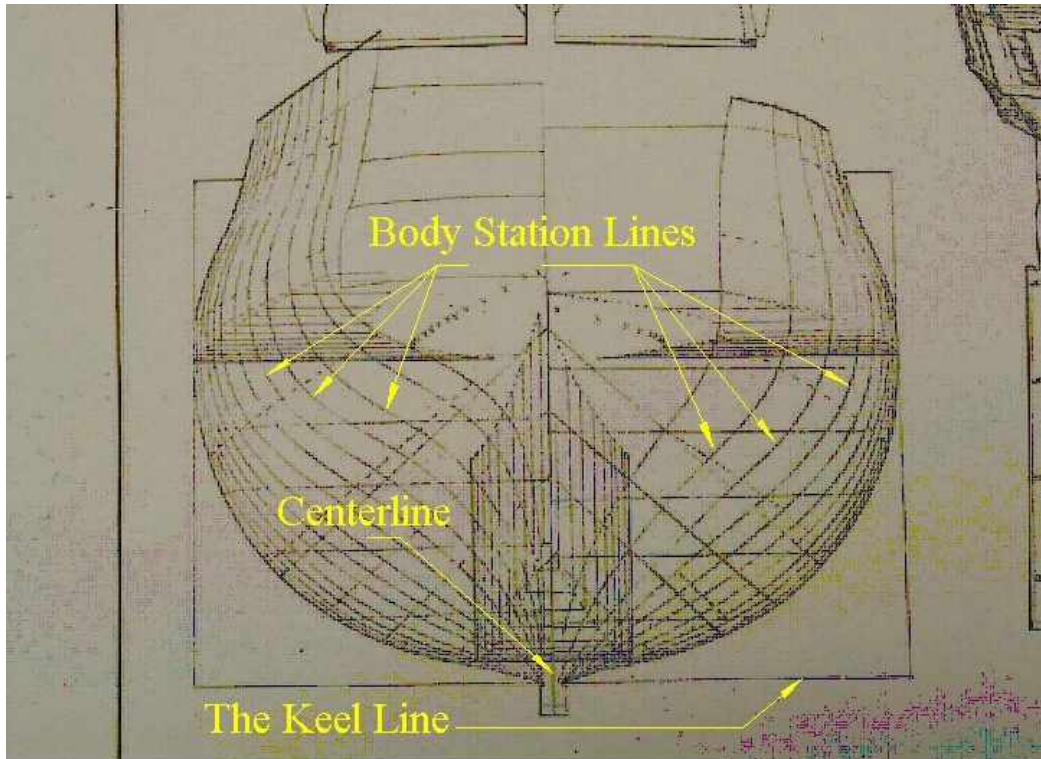

**HMS Boreas – The Body Plan**

Now we need to set a parallel line the same distance from the midline on the other side. We can't just click it into place since the paper plan may not be entirely accurate and the chance of actually sighting the line into the right place is pretty slim. Instead, select the side line with the select tool. Find and click on mirror copy. This tool will copy the item selected around an axis that must now be indicated. Our axis is the keel midline. A normal procedure is to select the sideline (the line to be copied), select "Mirror Copy," define the axis with two points placed on the midline, and (if necessary) tell the computer to leave the original line. This tells the computer to draw a copy of the first sideline as a mirror image. Now we have three parallel lines representing the sides and the middle of the keel. With a bit of luck and a reasonably accurate paper plan, your second side line should lie on top of the paper plan's sideline. Don't worry if it is off slightly.

Tracing in the bottom of the keel is completely optional, but it will give a sense of completion to the keel elements. Tracing in the notch of the rabbet is a noble thing to do, but is also optional.

**Defining the width of the hull** occupies our attention now. At this point you should have a base line and a midline for the body plan. The next step is to indicate the width of the body plan with two lines perpendicular to the keel line that intersect the body plan at its widest points. Again, these lines may be on your paper plan, and again do not trace them.

Using the same procedure as we used for the forward and after perpendicular lines on the profile plan, click on the keel line. Then set the cursor on the widest point of the body plan and click. The last step is to extend the line to a point above the body plan. By repeating this process on the opposite side of the body plan you will have defined the width of the hull.

If your conscience is clear and your heart is pure, the two width lines you have drawn in are exactly the same distance from the midline. This, however, seems unlikely to me for many reasons both philosophical and theological. However, if your paper plan is close to accurate, your tracing will be accurate enough. I mention this only to let you know that I know that you might wonder about it.

Eventually, we will resize the tracing in order to make the starboard and port dimensions equally spaced off the midline.

**Tracing the body lines** is a straight forward and process. Just use the spline tool to trace these graceful lines of the hull. See, wasn't that simple.

On the other hand, there are a host of problems that can leap up in this little exercise. For one, if you have a large number of body lines, say two or three dozen, the lines will tend to run into each other in several places such as at the keel and at the outside edges. Trying to read these lines for tracing can only make your optometrist happy. The good news is that, if you have three dozen lines, you probably only need a dozen and a half of them any way.

For example, at the widest part of the hull, the lines run together because the hull is curved very little. Just look at the mid-ship area on the half breadth plan and you will note how the waterlines are almost straight. Obviously, we don't need ten points to define the curves at this point; three or four would actually do quite nicely.

So, here's what we can do with all those body station lines that are running together. We can probably be well enough off by tracing every other line. Or, if you prefer, trace all the lines that you can trace with confidence. If a particular line is too unclear, you can try to trace it but keep in mind that you may not need it any way. Traced lines that are too full of guesswork can be changed to a different color to indicate that they are less reliable.

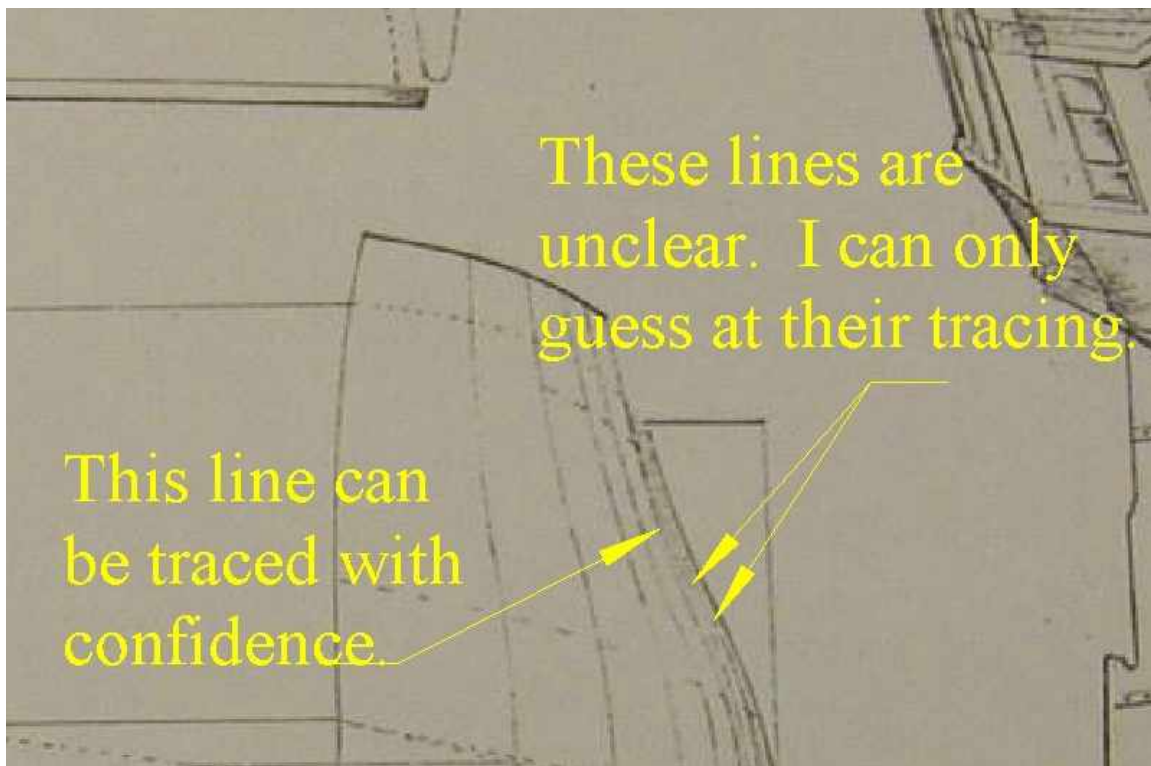

**HMS Boreas – Problems Tracing the Body Plan.**

At the keel we run into a similar problem. The outside line must be traced and, fortunately, is the easiest line to discern. Other body lines at the keel may have different levels of clarity. Again, trace what you can. Sometimes you just have to make do with what you've got. As a matter of fact, I am looking at an admiralty plan where some of the lines begin clearly in the underwater part of the hull, but disappear entirely in the upper works. While this is somewhat frustrating, I really only need the clear parts more than the missing parts anyway.

Normally, I begin a line at the keel and trace it up to the cap rail. I don't know it makes any difference, however. Many of the body lines will begin at the intersection of the keel line (top of the rabbet) and the keel side line. When this is the case, use this intersection to begin the line. If the body line

you are tracing is far enough forward or aft, it will begin at a point higher up along the keel side line. In these cases begin at a point on the side of the keel.

Begin tracing a line at the point where it comes away from the keel. Then trace the body line with a series of points placed on top of the paper plan line. Remember, where the line has a sharp curve you will need more points; where the curve is less severe fewer points will suffice. Simply keep an eye on how the spline is falling on top of the line being traced.

With the keel lines indicated and the body station lines traced we are close to done, but not quite.

**A few extra lines** remain. Depending on your particular plan, you may see the outlines of the stern drawn in. These may be traced if you like.

What about the waterlines? On most body plans the waterlines are indicated as a series of near horizontal lines. Often the water lines are not straight and do not meet at the keel midline. I think I can explain why this happens, but I also think it won't advance our cause very much. When we start fairing up the plans, we will want to create our own waterlines at any rate. The waterlines we insert in the profile will be extended to cover the body plan during the fairing process. I would not trace in the waterlines on the body plan in the interest of simplicity.

If you have a really good paper plan, the body plan will include a ton of other lines, ticks and sweeps. It is sufficient to say that these additional lines and marks were used by the naval architect to design the ship. We are not designing the ship so we do not need to reproduce more than the basic lines.

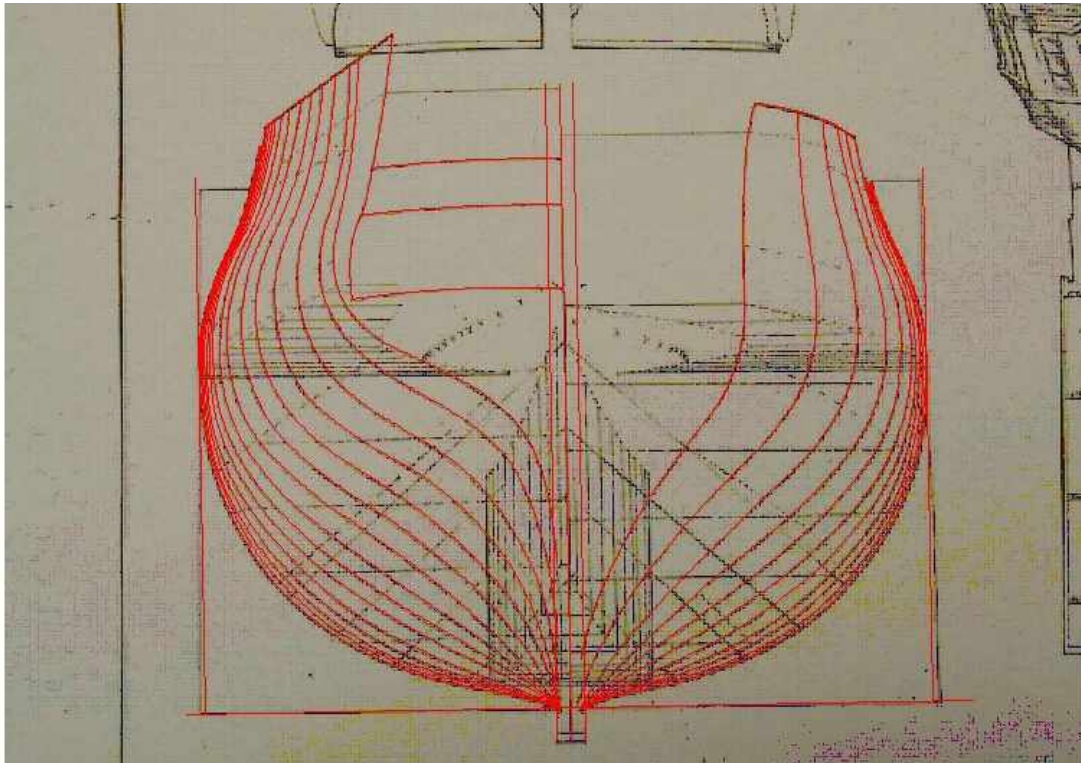

**HMS Boreas – Body Plan Traced**

The diagonal lines can be very important for producing an accurate drawing. Essentially, the diagonal lines provide a more precise way to locate points for determining the shape of the hull. If you are interested, it has to do with the margin of error introduced into finding the intersection of two lines that come together at a rather acute angle. Your CAD program will find an intersection point without error. Thus, the diagonals are not as necessary as they would be for a manual drafting process. They could be used to some advantage in CAD, but at this point in the learning curve the diagonals would only introduce an added level of complication far exceeding any benefit that might be gained. If you want to use them, go ahead. For my part I will not mention them again.

**That's it** for the body plan. It may surprise you how quickly this part of the tracing was completed, especially as you started to get the knack of recreating a curve with the spline tool. It is not very difficult to do if you just keep your wits about you. Try to understand what each line would represent on the actual ship. This will keep you properly oriented while you are tracing.

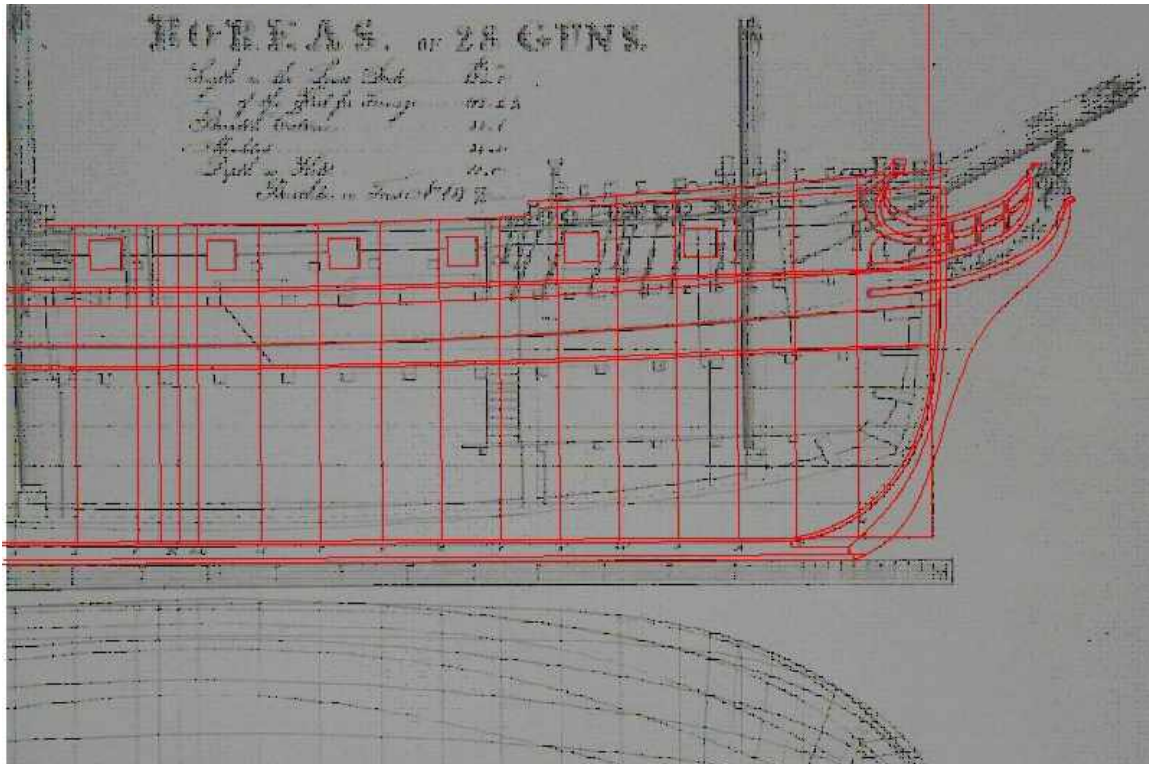

**HMS Boreas – Forward Profile Plan Traced**

### **Summary**

So far you have traced onto your computer drawing area the lines depicting your ship. While the work has been fairly basic, you have noticed your confidence growing. If you were to delete the paper plan photograph from underneath your tracings, you would see just your CAD lines forming a recognizable set of ship plans. I think you also would be impressed with your work. In fact, you might want to try that now (but save your working file first!).

Think of this tracing process as a data entry endeavor. You have been putting information about the shape of your ship into the computer. You could have recorded the information as a series of measurements. Instead, CAD allows you to enter the information as a series of lines and curves. A picture is worth a lot more than a thousand words in this case.

In subsequent steps we will use this information to redraw almost every line you have traced thus far. We will cross reference information on the body plan with the half breadth plan and profile plan. We will end up with a set of lines that are in perfect harmony with one another in all three plans.

## Scaling the Plan

I prefer drawing out the plan in CAD at a 1:1 scale. Because CAD gives us a virtually unlimited drawing area, we can draw a picture of our ship that is, as far as the computer knows, the same size as the actual vessel. So, for example, if the ship's length between perpendiculars should be 124 feet, the CAD drawing will show that distance as well.

There are several advantages to drawing the plan at full scale. The reference books will tell us the size of the various parts of the ship in real world measurements. If I were drawing my plan on paper I would have to convert each one of these measurements to scale dimensions using the appropriate scalar. This leads to a lot of calculations with the attendant opportunities for error. At full scale I simply use the real world dimensions in the CAD drawing. For example, if my keel should be 19 inches across and I am drawing at 1:64 scale (3/16ths inch to a foot), I need a CAD keel that is .296875 inches across. Some people might enjoy all those decimal places, but I find it easier to draw the 19 inches. When the entire drawing is finished it can be re-scaled with just one operation.

We will level our tracings, scale them up to full size, and then orient them properly with respect to one another. If you loaded your plans in with multiple photographs of the profile and half breadth plans, this is the time to take the extra step of putting the tracings together.

### Putting Plans Together (Part One)

In the event you have entered your paper plan onto the drawing area as one photograph, you can skip this section. The following relates to the use of multiple images for the profile and half breadth plans.

You have traced the plan sections on top of the respective photographs. The profile plan, for example, might have three parts. In the tracing process, you should have reproduced all of the lines on that section: keel, cap rail, station lines, etc. In order to join these sections together we need one more thing.

Because the section photographs overlap we can find a line on each section that is identical to the section beside it. For example, my mid-ship section extends forward to include the fourth gun port and my forward section extends aft to include the fifth gun port. Therefore, a line that lies between the fourth and fifth gun ports will occur on both sections. I can use this line as an index to size and join the two sections. Here is how.

First, I want to draw a perpendicular line that begins at the keel line and extends upward. The key is to terminate this line at a clearly identified point on the photograph. We could use the intersection of one of the station lines with the cap rail (assuming I was careful to trace the cap rail in the same manner for both sections). After placing this line on, say, the forward section, I must repeat this process on the mid-ship section. Again, I draw a perpendicular that begins at the keel line and terminates on exactly the same point as I chose for the forward section. In this case, the word 'exactly' means just that. Whatever part of the fuzzy blur you used when you zoomed in for the forward section, use that precise same part of the fuzzy blur in the mid-ship section. The fate of the universe depends on your accuracy at this point. Be just as precise as possible.

When we join the two sections together, we will re-size one of the sections so that these two index lines (one on each section) are the same length. The process we use will re-size the entire section proportionately. The result will be two sections that match in scale. Joining them together will be a simple matter.

Wherever sections overlap we need to indicate a set of index lines. In the case of using three photographs, there will be one on the forward section, two on the mid-ship section (forward and aft) and one on the stern section.

For the half breadth plan, the process is repeated (if you traced it). The index lines will begin at the keel line and terminate on a clearly identifiable point on the photograph. It may be the intersection of a station line with a waterline, for example. The key thing is for the terminal points of the index lines to fall on exactly the same point on the photograph.

We don't join the sections together yet. They must be leveled first.



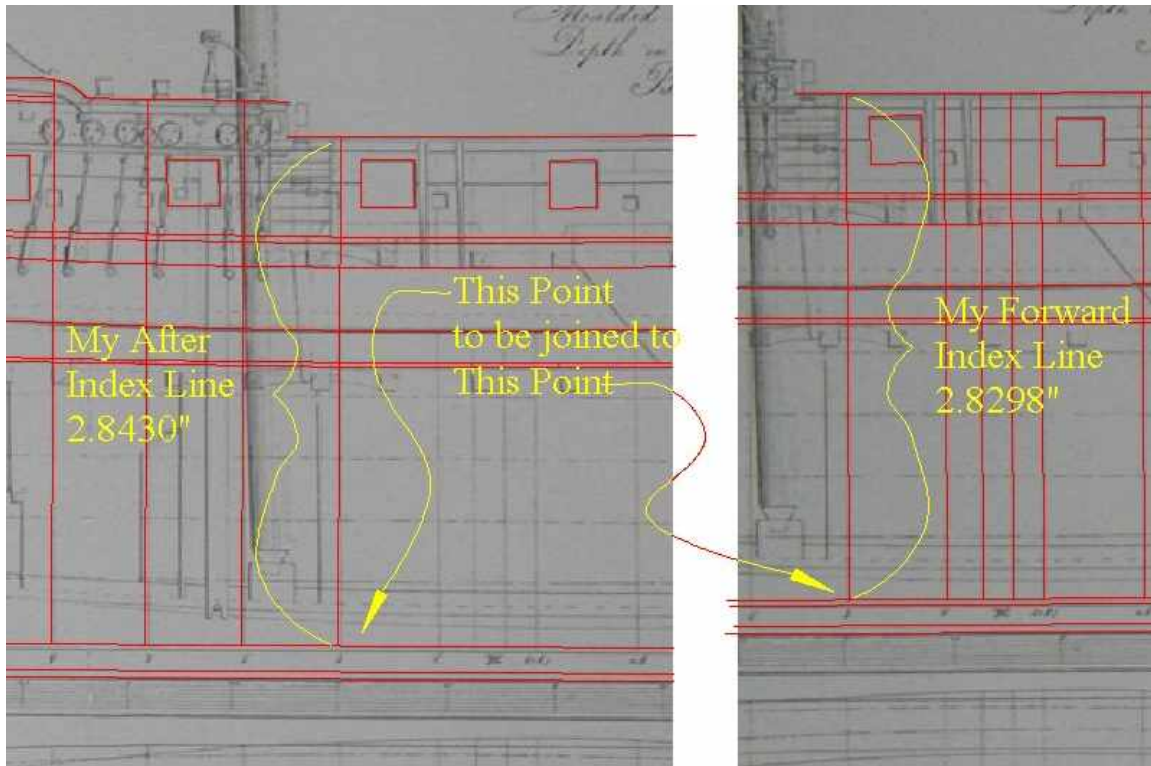

**HMS Boreas – The Index Lines**

## Leveling

You may have the option of leveling your photograph along with your drawn lines. My inexpensive CAD program will not rotate photographs and so I have waited until now to level off my drawing. Earlier, just after tracing in the keel line on the profile plan I suggested that it could be leveled at that point on some CAD programs. If you have skipped ahead to this point while tracing, the following method will do the leveling, but do not delete the photograph when performing the leveling operation. Once the image is level, return to the tracing process. The advantage is that you will be able to use orthogonal features to create your perpendicular and parallel lines if you wish.

So far, my inexpensive CAD program and I have not worried about the orientation of the photograph with respect to the drawing area. Whether it was up, down or sideways, the procedure I have outlined will work just fine. Yet, CAD will behave even better for us if we can take advantage of the orthogonal tools in the program. CAD will automatically draw lines in perfectly horizontal and perfectly vertical directions. By leveling our tracing in line with the horizontal we are in a position to use these orthogonal capabilities. The process of leveling the tracings is the same for each of the three plan perspectives: a) measure the angle made by the keel line and a horizontal line, b) select the plan under consideration, c) rotate the plan by the angle previously measured, d) admire our clever work.

You are excused if you skip to the last paragraph in this section and read about an alternate method of leveling. I used the following method before realizing how much simpler the process could be, so I include both approaches. Both work just fine, but on balance the alternate method is simpler.

**Say goodbye to the photographs** since they are no longer needed. We have extracted all the information from them possible. Simply delete them from your drawing area so that only your traced lines remain. (Of course, you are saving the progress of your work in separate files.) From now on, unless otherwise indicated, all references to the profile, half breadth and body plans refer to your CAD drawings, no longer to the photographs.

A small excursus on layers might be in order here. Some may prefer putting the photographs on one layer, tracing on another layer, and then fairing on yet a third layer. There is some advantage to using layers in this way in that you can add and subtract components of your work from the drawing area as the

situation demands. I have not chosen to use layers for no reason save that of simplicity. Well, cost may be another reason. My inexpensive little CAD program will not rotate photographs, something you would have to do in order to have all the layers orthogonal to the drawing area. Better CAD programs will rotate the photographs. If yours will, and you so desire, then have at it. The process I am outlining here will work without layers.

Confession is good for the soul, and so I will make a small admission here. If your CAD program allows you to rotate the photographs, you could have leveled the picture immediately after drawing in the keel line. Doing so would give you the advantage of using orthogonal features of your program in lieu of the perpendicular features. Computer drawing gets to be fun as you discover there are often several ways to accomplish the same end.

I present in this essay a fairly blunt approach to the question of lofting out ship plans in CAD. I do so using an inexpensive program. The principles and approaches I suggest should work in better CAD programs whereas, had I employed the advanced features of the more expensive programs, those readers using the less expensive programs might have thought themselves precluded from the attempt.

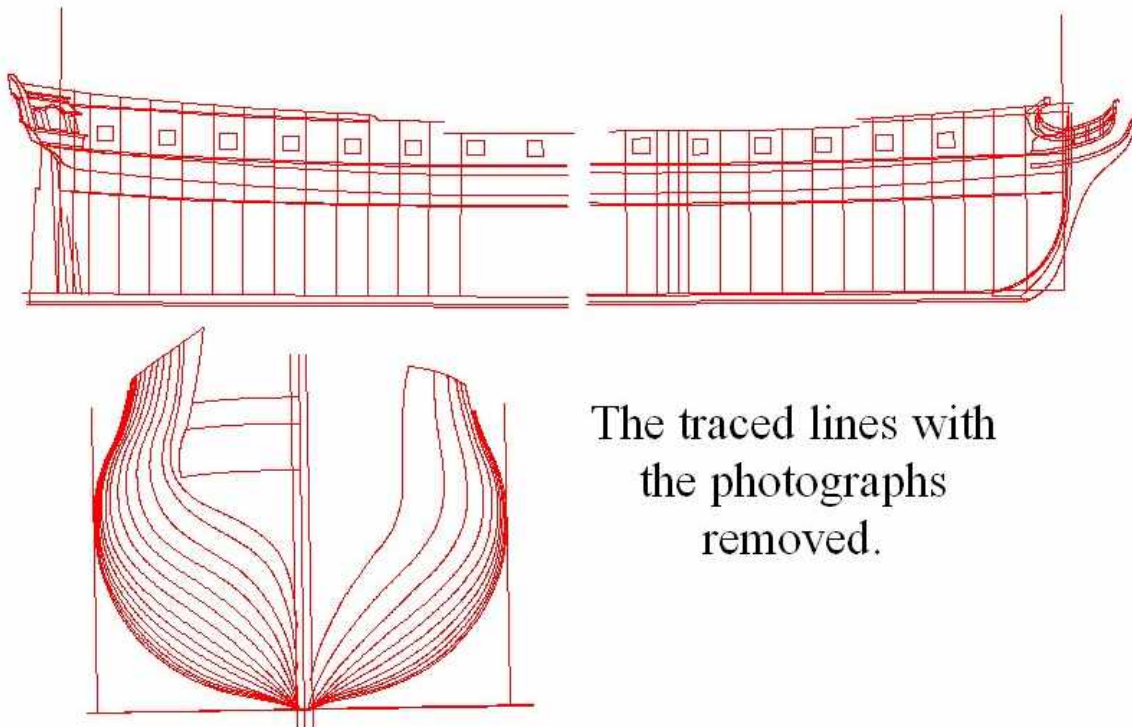

The traced lines with  
the photographs  
removed.

**The profile plan** can be leveled quite easily. To do so we return to the first line we drew, the keel line (running along the top of the rabbet). We need to know the angle of the keel line to the horizontal. This can be found by setting a horizontal construction line so that the keel line and the construction line intersect at some point. Since this angle may be quite small, having the construction line intersect one end point of the keel line will help matters along. Then, use your measurement tool to determine the angle these two lines form. I would suggest you measure to an accuracy of .0001 inch. I say this because my CAD program uses a default precision of four decimal places for internal calculations. This has proven to be more than adequate, so I chose to mimic the computer's level of accuracy in all my measurements. Somewhere in your program you should have the option of setting your preferences. Consult your reference manual or help topics to see how this is done. The construction line can now be erased.

There are several ways to rotate objects in CAD programs. Indeed, like most computer applications, there are almost always more than one way to accomplish any given task. For example, tools can be selected through the menu bar or by icon; line lengths can be set with the mouse or through the keyboard; snap modes can be chosen by icon, menu bar, or keystroke. I will trust you to gain some proficiency with your own program so that you can follow the steps I am indicating. Rotating the profile plan is a good example of choosing the best method for you to accomplish the task. A really, really good

person could rotate the plan by eye. I can't so I entered the degree of rotation through the keyboard. Unless a certain Mr. M. Mouse designed your CAD, you will have the option of typing in the angle of rotation.

Select your profile plan. In the manner indicated by your program documentation, enter the previously measured angle for rotating the selection. After you enter the angle of rotation you should see the keel line become a perfectly straight line on the horizontal plane. Remember, depending on the way your photograph was inserted into the drawing area, your tracings will rotate in either a positive or negative direction. If you enter the angle of rotation and the keel line only gets worse, you probably need to rotate in the opposite direction.

Just to be clear about all this, you are rotating the entire profile plan, not just the keel line. It is the keel line that must be perfectly horizontal so you measure the angle of the keel line. But the whole plan must rotate in concert with the keel line.

You will also recall that we did not trace the perpendiculars. Instead, we were careful to draw in lines that were at precise right angles to the keel line. It now should be evident why we did this. With the keel line set on the horizontal, the perpendiculars are now set perfectly on the vertical. These three lines, the keel line, the forward and the after perpendicular, are the foundation for the ship's dimensions.

**The half breadth plan** would be leveled in exactly the same manner as the profile plan. The angle of the keel line is measured with respect to a horizontal construction line. The whole plan is then selected and rotated in the appropriate direction by the angle measured. The perpendiculars are now vertical, the keel line horizontal, and all is right with the world.

If you elected to skip tracing the half breadth plan, just be patient. We will establish a keel line and perpendiculars for the half breadth in just a moment.

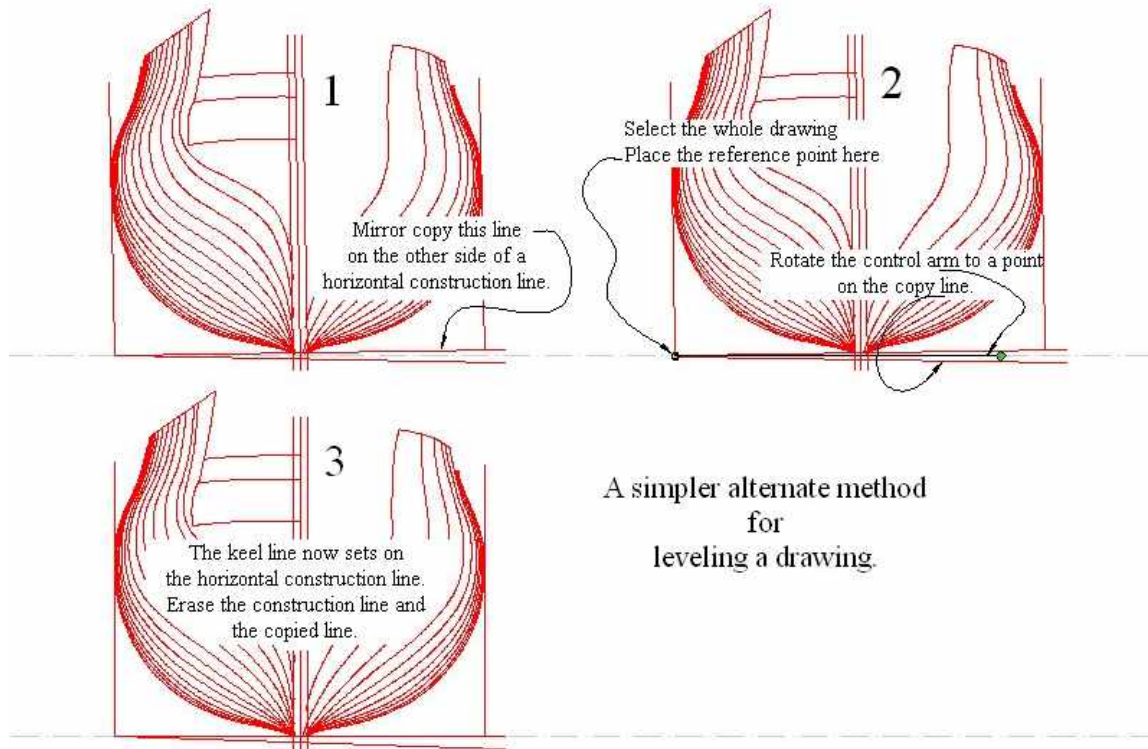

**The body plan** is also leveled by measuring the angle of the keel line (running along the top of the rabbet), selecting the whole plan, and rotating in the appropriate direction by the angle measured. In this instance, the lines at the sides of the body plan are now vertical. This is why we did not trace them but constructed them at a right angle to the keel line.

**An alternate method** for leveling the plans is simpler in that it does not require measurement of the angle of the keel line. First, set down a horizontal construction line so that it intersects the end of the

keel line. Select the keel line and make a mirror copy with the construction line as the axis of copying. This will put a copy of the keel line on the opposite side of the construction line. Now select the entire drawing to be rotated. Place or move the reference (base) point to the intersection of the keel line and the construction line. Now rotate the drawing until the rotation arm (which is horizontal by default) rests on the copied keel line. The original keel line obviously now rests on the horizontal construction line. Erase the construction line and the copy of the keel line and you have a leveled drawing.

### **Putting Plans Together (Part Two)**

If need be, we can join our sections together now that each section of the plans has been leveled. The index lines that we drew earlier will make this fairly straight forward.

**The sizes of the sections** need to match. The photographs you took of your plan will not be the same scales. Humanity being what it is, one will be larger than the other. The distance between the keel and cap rail (for example) on one section will not be the same as on the other section. We will resize one of the sections so the distances match. Then we can join them up.

We begin by measuring both index lines. Call one of the lines N1 (N for index) and the other N2. Record their lengths to four decimal places. Mathematically, their relationship will be  $N1 = N2 \times S$  where N1 and N2 are the lengths of the index lines and S is a scalar (number) that expresses the relationship of the two index lines. N2 denotes the index line on the section we are going to resize. The value of S is  $N1/N2$ . So, on your calculator (which some CAD programs include) divide N1 by N2. Write this number down to at least four decimal places. (You may have to adjust your unit default settings. Consult your reference manual and help topics to see how this is done in your program.)

Now, select the section that contained N2. Your CAD offers you the opportunity to set the scale of the X and Y axes. Type in the value of S for both the X and Y scales. This procedure will resize the section in both the horizontal and vertical directions by the value of S. As a result, the sections now match in scale. You can double check this fact by measuring both index lines again. They should now be the same length.

For example, if N1 is 2.8430 and N2 is 2.8298 then the value of S is  $2.8430/2.8298$  or 1.0047. The section with N2 must be scaled by 1.0047 on both the X and Y-axes.

My expensive CAD program performs this operation a bit differently, but the principle is the same. Expressed simply, we are resizing one drawing so that it has the same size and scale (based on the index line) as the other drawing. Read up on scaling in your help topics for more information.

**Joining the sections** is just a matter of moving one index line on top of the other. Select one of the sections. Move the reference point to the intersection of the index line and the keel line. (The intersection snap mode makes this, well, a snap.) Grab the reference point and move it to the intersection of the index and keel lines on the other section. The two sections are now joined. The two keel lines should now appear as a single straight line. Because we first resized the sections, all the traced lines should fall virtually on top of one another. They won't exactly because our tracing was a human endeavor. On the other hand, I should think the lines will be close enough together that you will take some pride in the result. As long as they are close we are in business.

This process of resizing and moving is repeated for the remaining section. Start from the very beginning with measuring the index line on the new composite section. Measure the index line on the third section and calculate the value of S. Scale the third section and move its index to the index on the composite section. There you have it. Your tracing in three parts is now one.

**Some cleanup may be needed.** Because the traced lines are not exactly the same in the overlap regions of our drawing, we may want to eliminate the confusion. This is not too hard to do. We'll just split the difference.

Actually, I would guess that your traced lines are no more than a pencil line width apart where they overlap (less than .02 inches). Thus, when you redraw the lines and "split the difference," you really aren't generating too much variance from your original tracing

For example, the wales would look a lot better as one single curve rather than as two or three. Just trace a new wale on top of the other tracings. Where the lines are not the same, place your points at your best estimate of the correct location. Most of the new curve will fall on top of the original tracings anyway

(use a “nearest on graphic” snap mode for that). Once you have traced in a new curve, go back and delete the original traced lines. Now the curve of the wale is one graceful line. This can be repeated for the cap rail and deck lines as well.

The keel line really should be one line in fact, not just in appearance. Right now the keel is actually two or three lines on top of each other. We could draw a line on top of these three, but that would just give us four lines to deal with. The perpendiculars can help us out here. If you created the perpendiculars as beginning at the keel line, the lower end of the perpendicular lines also define the keel. Thus, we can erase the three lines on the keel line. For a moment we have nothing to show for the keel line, but as soon as we draw a straight line between the lower end points of the perpendiculars we once again have a single keel line. CAD allows us to lengthen this line if we like. A similar procedure can be used on both the profile and half breadth plans.

The waterlines on the half breadth plan will also show some variation (if you traced them). In the fairing process we are going to redraw the waterlines anyway, so these traced lines can remain as they are. We will use them for reference purposes, but they do not need to be reworked in the same way we redrew the wales, for example.

The plan we had separated into two or three photographs is now appropriately rejoined. When you think about it, it was just a matter of using an index line to size the sections to the same scale, then joining the sections. CAD gives us the tools we need to accomplish this task fairly easily.

## Scaling

While the actual size of your computer screen is limited, the “size” of your drawing is virtually unlimited. This is a great advantage over a paper drawing in that we will use real life dimensions the way the shipwright would in cutting out the various members of the ship. Our next procedure, then, will enlarge our traced lines to indicate the full scale of the ship.

Somewhere you have obtained the length of the ship between the perpendiculars. On the plan this may have been labeled “Length of Gun Deck” or some such description. With this knowledge in hand we are in a position to scale up our plan.

**Measure the plan’s length.** A horizontal construction line can be placed so that it crosses both the forward and after perpendiculars. Take the measurement of the distance between the points where this construction line intersects the perpendiculars. It is this distance that we want to match the real world length of the ship. The mathematical relationship of the two distances is  $L1 = L2 \times S$  where  $L1$  is the length of the real world ship,  $L2$  is the measured length of the CAD drawing, and  $S$  is the scalar defining the relationship between the two. The value of  $S$  is  $L1/L2$ .

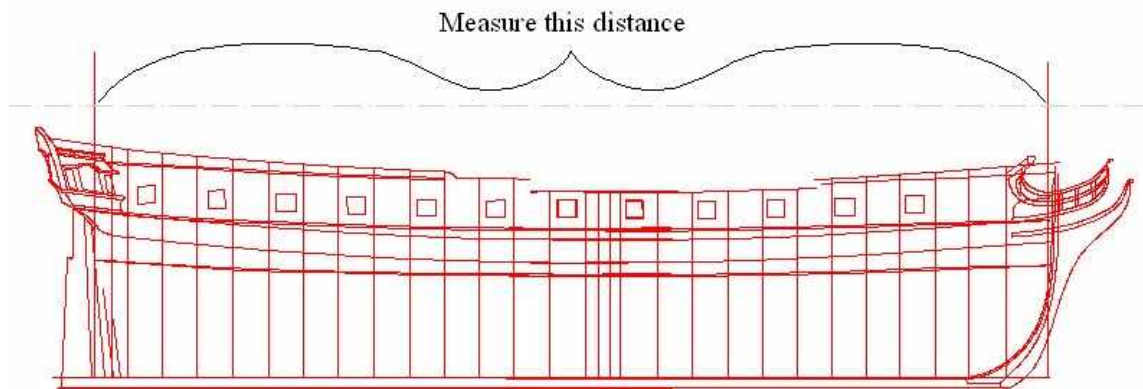

**Rescale the drawing** by selecting the plan. Then enter in the value of  $S$  for the scaling of both the X and Y-axes. If you were to repeat the above process of measuring the distance between the perpendiculars you should find it now equals the real world length of your ship.

For example, my traced drawing measures 14.6438 inches between the perpendiculars. I know that the real dimension is 124 feet or  $124 \times 12 = 1488$  inches. Thus,  $S = 1488 / 14.6438$  or 101.6130. After selecting the plan in the drawing area, I scale the X and Y-axes by 101.6130. This gives me a drawing with a dimension of 1488 inches (124 feet) between the perpendiculars.

This process is used for both the profile and half breadth plans (if traced).

**The body plan** offers a different set of challenges. In essence, the process is the same except that the width of the ship is used in place of the length. The challenge comes in that we must be sure the tracing is first adjusted properly.

You will remember the two perpendicular lines coming up from the keel line that defined the width of the body plan. In theory, these two lines will each be the same distance from the vertical centerline of the keel. In actuality, your lines are probably slightly off. To correct this, we can use the mirror copy tool.

Select one of the perpendicular lines. Then perform a mirror copy operation using the centerline of the keel as the axis of copying. This will place a line on the opposite side of the plan at the exact distance of the selected line. In a perfect world, this new line would fall on top of the other perpendicular you traced earlier. In reality it will be off by some amount. Now, repeat these steps with the other traced perpendicular line. Now each side of the body plan has two lines, the original line and the mirror copy of the opposite side line.

On one side one of the lines will fall inside the bodylines. On the other side one of the lines will fall outside the bodylines. It is this side of the plan that we want to adjust. Select the bodylines on this “thin” side of the plan. (You are selecting only half of the bodylines, and do not select any of the keel lines.) Then, drag the outboard side of the selection box to coincide with the outside perpendicular line (the nearest on graphic tool makes this possible). In effect, we are stretching the “thin” side of the plan to the same width as the “thick” side of the plan. Even on a really distorted plan the amount of adjustment probably is not more than a tenth of an inch or so. On a decent plan the adjustment may not even be discernible. The extra lines that fall inside the body plan should now be deleted.

This adjustment process gives us a symmetrical body plan. All of this, of course, is based on the assumption that the body plan has the dead flat line as the outside line on both sides. This is usually the case. Nonetheless, I think you see the idea. We need a body plan where the outside lines on each side represent the same place on the hull and where both sides are equidistant from the centerline.

Near the middle of the hull there will be a section where a number of the frames will have the same size and shape. There may be almost a half dozen frames that show no appreciable bevel on them. This is the dead flat area, so named for obvious reasons. In point of fact, the forward side of the body plan may end at the forward part of this section. The after side of the body plan may end at the after side of the dead flat area. This means that the outside lines on the body plan may actually represent two different stations or frames. But, since they are both a part of the dead flat area, they will share the same breadth from the keel. For this reason, the process here suggested will work out just fine.

Now the body plan can be scaled up using the same process as for the profile and half breadth plans. We need to know the width of the ship. This is expressed as either the moulded breadth or the extreme breadth. Sometimes both are given. The extreme breadth is the width of the ship included the planking of the hull. With this planking removed, the moulded breadth is the width of the ship at the outer sides of the dead flat frame (amidships). Because we are interested in defining the shape of the framing, we need the moulded breadth. If this is given as such, then all well and good. If only the extreme breadth is given then you must subtract twice the thickness of a plank. For instance, my plan indicates 33 feet 6 inches for the extreme breadth. I subtract 6 inches for the thickness of two planks (one on each side). The result is 33 feet even for the moulded breadth. This is the distance I need to show between the side perpendiculars on the body plan. I just happen to know that this is correct, but you will need to look up the thickness of planking for your ship before doing a similar calculation. The moulded breadth really should be given on your plan as was the case on the plan I used for this example.

So, with the whole body plan selected the value of S is entered for scaling the X and Y-axes. To continue the example above, the body plan on the drawing area measures 7.2205 inches. The real world ship is 33 feet or (33 x 12) inches or 396 inches. The value of S is  $396 / 7.2205$  or 54.8438. Entering this number for scaling the X and Y-axes gives us the right dimensions for the body plan.

**The basic principle** in scaling up the traced plans in CAD is to calculate the relationship of the plan to the real world (which, by the way, is the true scale of the tracing) and then multiply the plan by its own scale. This yields a drawing with full size dimensions. Believe it or not, we will not be addressing matters of scale for quite a while as we turn our attention to fairing up the plans with one another.

## A Finishing Touch

We have been treating the half breadth plan like an orphan child. Every time I have mentioned the waterlines I have also indicated how unnecessary it was to trace them. Now we can construct the beginnings of our final half breadth plan.

**We need a keel and two perpendicular lines.** In your drawing area, set down a horizontal line that exceeds the length of the ship. Now that you have scaled up your tracings, you can draw this line below the profile plan at a distance sufficient to allow water lines to be added. A vertical construction line should then be placed on top of the forward and after perpendiculars of the profile plan. Now draw a straight line that begins at the intersection of the new keel line with the construction line and rises to a point below the profile plan. This perpendicular line must end on the construction line, that is, it must be perpendicular to the keel line of the half breadth plan we are creating. Repeat this process for both the forward and after perpendiculars. Remove the construction lines.

It is important that the perpendiculars on the profile and half breadth plans line up (hence the construction line). But it is also important that the two plans can be separated easily for later operations (hence the separate line).

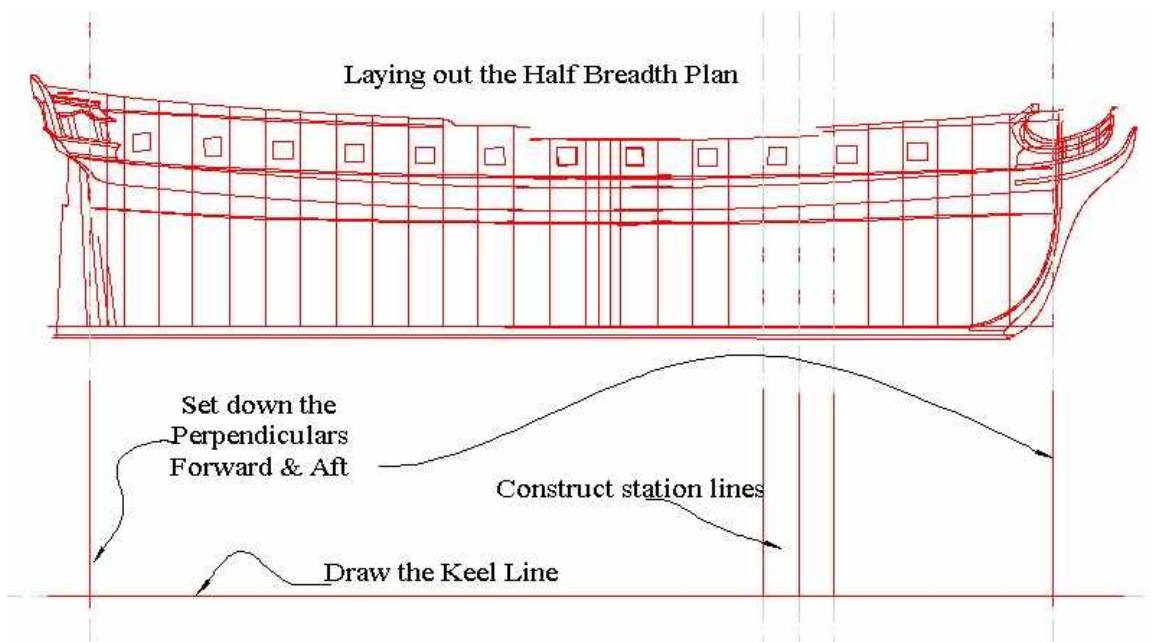

**The half breadth plan needs station lines** that match the profile plan. You will remember that we did not trace the profile station lines. Rather, we drew lines perpendicular to the keel at the places indicated on the paper plan. Now you will see why.

For each station line on the profile plan, follow the same procedure as you did for drawing the perpendiculars. As a result, your half breadth plan now consists of a keel line, the forward and after perpendicular lines, and a series of station lines. This is all we need to fair up our plan.

## Fairing the Plan

Fairing is the process of making sure the three plans all describe the same hull. The original plan should have been faired up so that our adjustments should be minor. On the other hand, an original plan can be a good bit off for a host of reasons. In this case, the faring process will require some attention.

Part science and part art, fairing our plan will demand judgment and sensitivity.

### Preparation

Our CAD drawing has been separated from the original plan and is now an entity unto itself. We have leveled the various parts of the drawing and scaled them up to reflect real world dimensions. Before going further, we want to align the plans with one another.

**A typical plan** shows the profile and half breadth plans above and below one another. More than just convention invites us to follow this practice. With the two plans aligned with one another in such a fashion, we can cross reference from one plan to the other with ease. Additionally, the body plan can be placed to the side of the profile plan, a position that also makes it easier to cross reference.

CAD makes this a simple procedure. Place a vertical construction line on top of the forward and after perpendiculars on the profile plan. Then select the half breadth plan and move it so that the forward perpendicular on the half breadth plan is on the forward construction line. Now the perpendiculars on the profile and half breadth plans align. (You can delete the two construction lines now.) This step is skipped if you did not trace your half breadth plan but constructed the appropriate lines during the scaling process.

Aligning the body plan takes the same course. This time, place a horizontal construction line on top of the keel line of the profile plan. Select the body plan and move it so that the keel line of the body plan rests on the construction line at a position to the left of the profile plan. (Delete the construction line.) Now the two keel lines are in alignment with one another.

Your drawing should now show the three plans with the profile plan above the half breadth plan and the body plan to the left of the profile plan. This is a fairly typical arrangement and will prove to be quite serviceable.

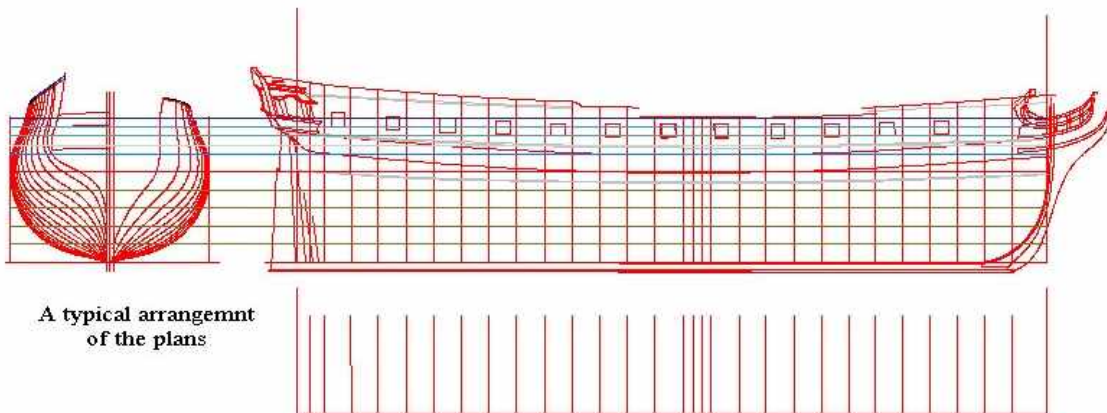

**Waterlines for the profile plan** should be drawn in next. We have delayed drawing them in for a long time, but there is no further profit in waiting. On the profile plan, the waterlines will be a series of lines parallel to the keel and equidistant from one another. The number of water lines is a matter of judgment. A lot of lines will make the drawing more accurate, but will also confuse matters somewhat. I would settle for something of a compromise.

I begin by drawing a series of lines parallel to the keel spaced two or three feet apart (remember, I am using real world measurements on my drawing now). A distance of two feet serves a smaller vessel better. Three feet is good for a larger ship of the line. I continue this pattern up to a point just about even with the wales. From this point upward, I double the number of waterlines so that they are now spaced every one to one and a half feet. These extra lines provide more reference points for creating tumble home. If the vessel you are working on has no tumble home, then fewer waterlines in the upper body will work



out fine. The highest waterline can fall somewhere below the level of the cap rail at the waist. The parallel line tool in CAD makes all of this a rather simple procedure.

Now it is time to employ the line length tool. CAD allows us to grab one end of a line and extend it to a desired point. As always, consult your reference manual and help topics if you need to know how your particular program does this.

We want to extend the waterlines on the profile plan so that they cross over the body plan to the left. Grab the after end of a waterline and pull it across the body plan. Do this for each of your waterlines. The body plan now has a keel line and a series of waterlines that exactly match the profile plan. These references lines are permanent fixtures and must never be moved or altered.

**A helpful but unusual step** occupies us next. Right now, we can project information directly from the profile plan to the half breadth plan using construction lines (as we did when we dropped the profile station lines down to the half breadth plan). We can do the same between the profile and body plans (as we did with the waterline extensions). But we cannot project information directly between the body and half breadth plans. Our task will be greatly simplified if we could, and CAD makes it simple.

Placing an exact copy of the half breadth plan below the body plan solves the problem. Place a construction line on top of the midline of the body plan. Next, select both the profile and half breadth plans (that's right, both). Then use the copy command to create a copy of the two plans in the drawing area. Rotate this copy 90 degrees so that it runs up and down with the bow at the top. Finally, select and move the copy of the profile and half breadth plans so that the keel line of the half breadth plan falls on the construction line (which is afterward deleted).

The station lines that you placed on the half breadth plan need to be extended so that they lie on both sides of the central keel line. The simplest way to do this is to select all the station lines on the half breadth plan and then use mirror copy to place a symmetrical set of lines on the opposite side of the keel line. (Of course, you used the keel line to establish the axis of copying.)

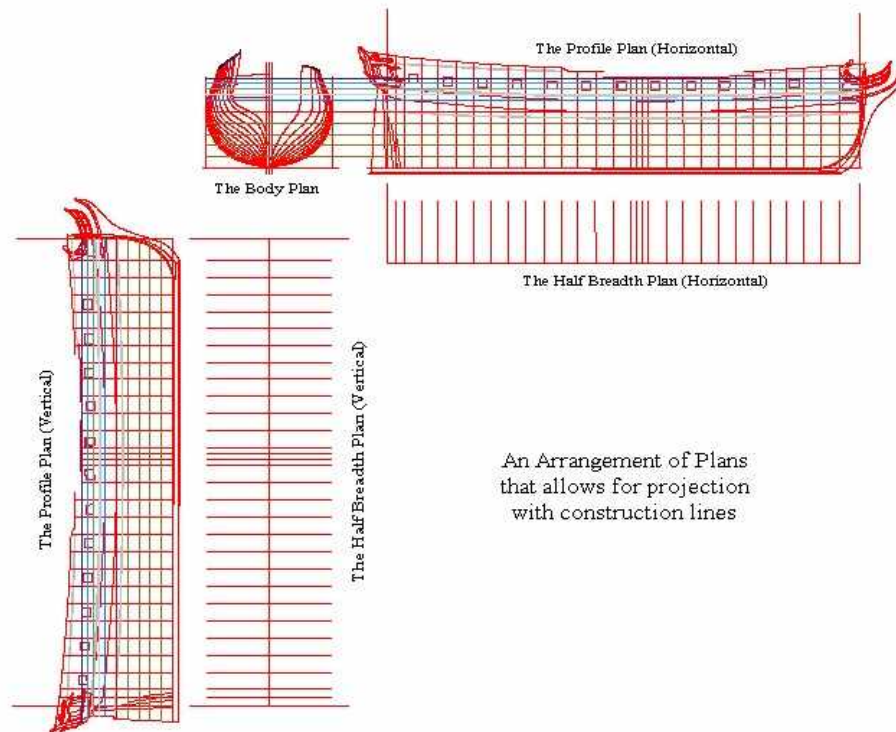

Now, we need to project the side keel lines from the body plan down to the half breadth plan. We could use vertical construction lines set on the body plan's side keel lines and draw a line on top of these construction lines for a length equal to the keel line. As a result, the half breadth plan would have three lines depicting the width and center of the keel.

But let me complicate things just a bit. If I were to calculate the actual width of the keel from the various formulae available, I would want my side keel lines to match the real world width, not the traced lines I drew in earlier. For example, for an 80 gun ship of the line with a beam of 49 feet 9 inches, my keel width is calculated as 18.65625 inches. In point of fact the plan I have of just such a ship has a keel that measures 19 inches. So, I might prefer drawing the sides of the keel 19 inches apart (or 9.5 inches from the centerline). However, when I build my model, I may find it more convenient to cut the keel out of stock that is a standard thickness such as 1/8 or 3/16 or 1/4 inches. By using an 18 inch dimension on my drawing, my model will be a bit simpler when I scale the plans since an 18 inch keel would be 3/16 inches at 1:96 scale.

To take another example, a little ship with a beam of 33 feet has an indicated keel width of 13.41 inches. However, if I choose a keel width of 12 inches, I will find my cutting of the keel a bit easier when I scale the drawing for a model. So, I would choose a 12 inch keel or keel side 6 inches on either side of the centerline. Naturally, if you plan to dimension your model wood to precise tolerances, certainly use the 13 inch width. The principle involved here is one of looking ahead to how you will use the plan.

All of this is to say, place two lines on your half breadth plan below the body plan to indicate the width of the keel. You can do so using the parallel line or offset tool to establish the sidelines parallel to the centerline.

We now have a way for the three plans to interact directly with either one of the other two plans. Your drawing has grown quite large, something that would be undeniably cumbersome for a traditional drawing. But in CAD it has been a simple matter with guaranteed identical drawings to the right of and below the body plan. With this layout on the drawing area we can begin fairing the lines.

**Keep in mind** that a perfect tracing of a perfect drawing will mean no fairing is needed. However, many plans contain distortions and inaccuracies. Whether we were using pen and ink or CAD, some final correction of the original plan would be necessary before we could use the plans for building a model.

## The Waterlines

The dirty little secret is that we had no real need for tracing the original half breadth plan. If you traced it, you may be wondering why I let you go ahead with it. All I can say is that it builds character and ennobles the heart. But all you really need is a keel line, the perpendiculars and a set of station lines matched to the profile plan. Thus prepared we are ready to start drawing our own waterlines on the half breadth plan.

Waterlines tend to run together in a confusing way, especially at the extreme breadth of the hull. Using different colors will help distinguish one from another. You might use one color for the lowest four or five lines (for some reason I like sienna). These waterlines rarely cross over one another. As you move upward, use a different color for each line. I like to use colors in the same family (such as various shades of blue) for the lines above the wales. Later, when reading a particular waterline you will be able to pick it out from a forest of lines more easily. Be sure to change to the same color of a waterline on all the plans. This way the waterline will have the same color whether on the profile, body or half breadth plan

**The half breadth outline below the body plan** will be the venue for drawing waterlines. You have drawn waterlines across the body plan's station lines. You have also drawn station lines across the half breadth plan. To put matters simply, wherever a body station line intersects a waterline there should be a corresponding intersection of the same station and waterline on the half breadth plan.

For example, I can place a vertical construction line on the body plan at the intersection of station line "A" and the third waterline (W3). If I follow this construction line down to station line "A" on the half breadth plan, I know that the third waterline (W3) will pass through the intersection of the construction line and station line "A." I can repeat this process for every place where a station line intersects the third waterline. Joining all these points in sequence on the half breadth plan will give me the complete first waterline.

Our method will be to drop a vertical construction line down from the intersections of body station lines and waterlines to the half breadth plan underneath. The line connecting the intersections of station lines and the construction lines on the half breadth plan will define the waterline.

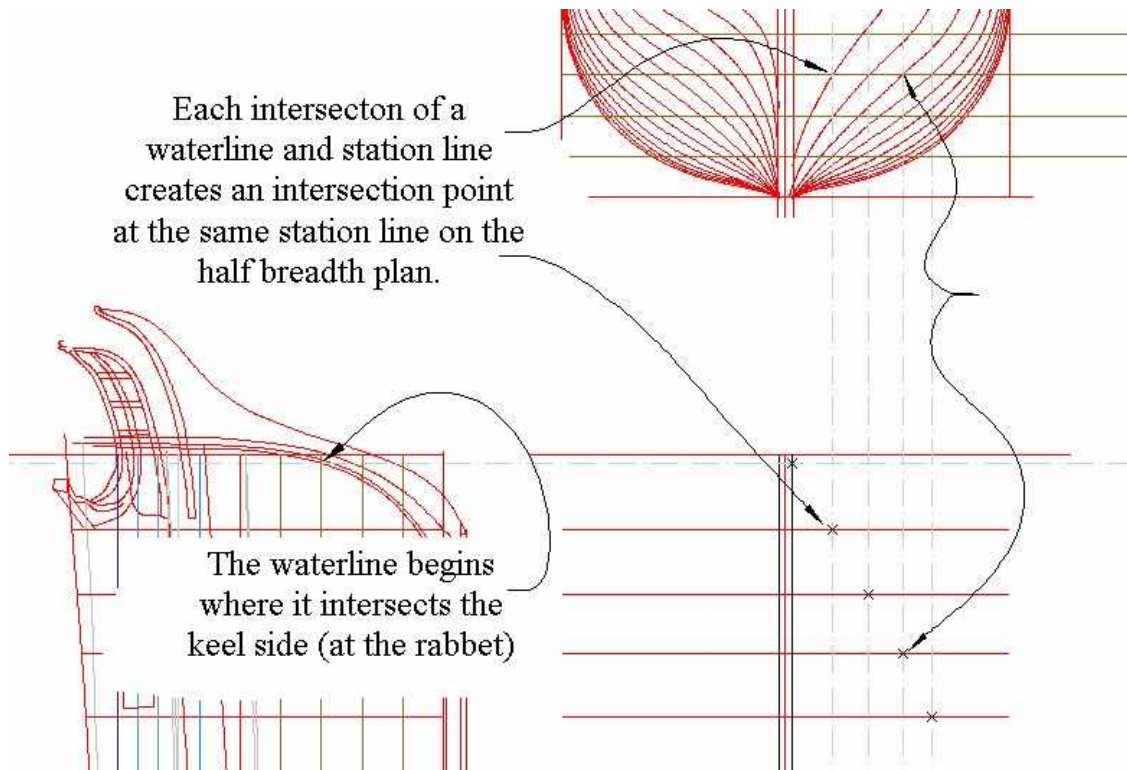

Let us begin with the lowest water line (closest to the keel). On the body plan, place a vertical construction line wherever the lowest water line crosses a station line. Do this for both sides of the plan.

Then move to the profile plan lying below the body plan. We made a copy of the profile plan along with the half breadth plan so we could project the beginning and ending points of the waterlines to the half breadth plan. Find the intersection of the lowest water line with the rabbet line at the bow (the after part of the rabbet as a matter of fact). Place a horizontal construction line at this intersection. Do the same thing for the intersection of the waterline and the rabbet line at the stern. These two horizontal construction lines project the length of the waterline to the half breadth plan.

A plethora of construction lines are cutting across your drawing. Each one defines a point on the waterline we are drawing.

**We need a system for connecting the dots.** A typical body plan has the forward station lines on the right and the after station lines on the left. I am going to draw my waterline on the right side of the half breadth plan below the body plan. There is no particular reason for this; it could just as well be done on the left side.

As you examine the half breadth plan, you notice the construction lines indicating the intersection of the waterline and the after station lines are all on the left side of the half breadth plan. The forward intersections have construction lines on the right. This is a good thing. If all the construction lines were on just one side of the plan then we would have total mayhem. The division of the lines allows us to work more comfortably in plotting the new waterline.

Let's begin with the after part of the line (on the left). Eventually, the waterline will be drawn in with the spline tool. At this point, however, I only need to project the points of intersection in the after (left) part of the drawing to the right side. There are several ways to do this, but the method I suggest here is as simple as any.

The polyline tool will connect the intersection points with a series of straight lines, and that is what I want to do now. With the intersection snap mode on, begin at the point where the after horizontal construction line intersects the side of the keel. This will be the point where the waterline terminates at the stern. Then, move up to the nearest station line and its corresponding vertical construction line. (Remember, the after perpendicular is not a station line and will not have an intersection point.) Going from station to station, connect the points of intersection. This will continue until you reach the mid-ship

area, that is, the outside station line of the left side of the body plan. At this point, pull your polyline away from the plan to any point lying outside the plan and finish your polyline. You will see the polyline

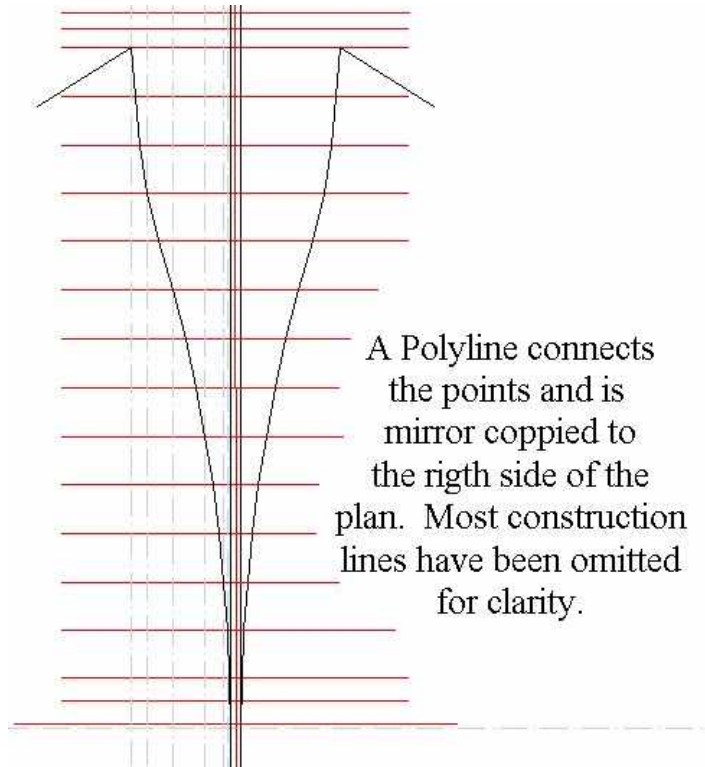

A Polyline connects the points and is mirror copied to the right side of the plan. Most construction lines have been omitted for clarity.

depicting something like the after part of the waterline with a tail shooting out amidships.

What you have just drawn is for reference purposes only. The polyline indicates the place on each station where the waterline crosses. The tail we added will be useful in erasing the polyline after it is no longer needed to draw the waterline.

Projecting the after intersection points to the right side of the plan will place both the forward intersections (by way of the construction lines) and the after intersections (by way of the polyline) on the right side of the plan. The mirror tool accomplishes this task. Select the polyline (the tail is the easiest part to click on) and then mirror copy it using the centerline of the keel as the axis of copying. You will now see the mirror image of the polyline on the right side of the plan.

The final waterline is drawn using the spline tool. It should be

apparent that a spline that connects all the points of intersection will give us the graceful curve of the waterline.

With the spline tool (and the intersection snap mode), begin at the bow where the horizontal construction line intersects the right side of the keel. Connect this point to each successive intersection of a

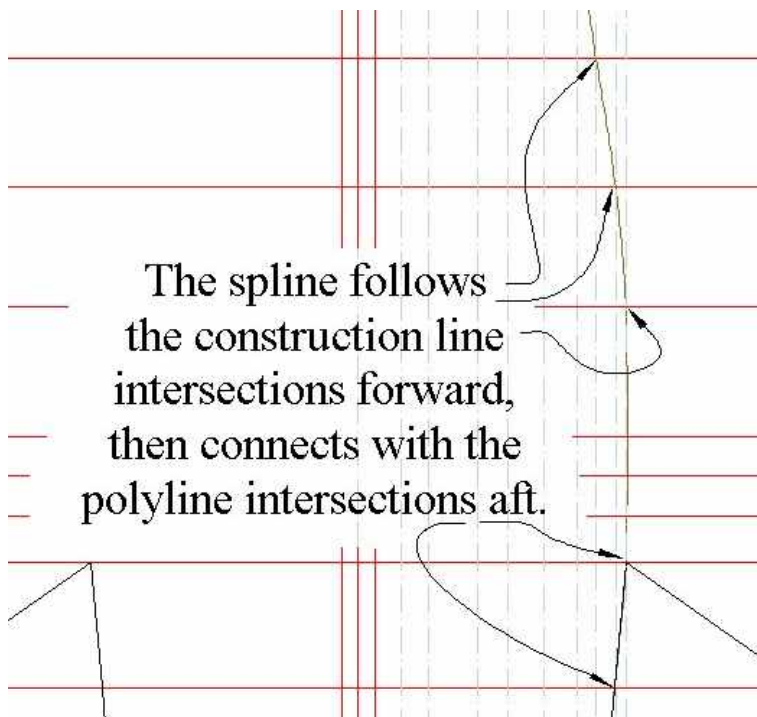

The spline follows the construction line intersections forward, then connects with the polyline intersections aft.

station line and the appropriate construction line. When you reach the last construction line (at the mid-ship area) then your next intersection point will be defined by the polyline.

Continue along the polyline until you reach the keel at the stern. Finish the spline and your waterline is done.

All the construction lines and both polylines can now be deleted. The tails of the polylines make them easier to select for erasing. You should be able to erase all the construction lines in one operation. Your help topics should tell you how.

This process may seem a bit elaborate the first time you go through it. By the second waterline you will be moving along pretty well. By the third your mind will begin to

daydream about other things, it is just that easy.

**All the waterlines** are drawn using this procedure. Drop vertical construction lines down from the body plan, insert horizontal construction lines from the profile plan, mark the after intersection points with a polyline (that is then mirror copied to the right side of the plan), and draw a spline along the series of intersection points. Learn this technique of using a polyline to mark intersection points. We will use it constantly later on when we begin to loft out the frames of the ship.

In a perfect world you will have no problems drawing each waterline. In the real world you may have the following problem.

When we were tracing the body plan, I indicated that you may have trouble seeing the lines at the outer edges of the plan. The hull at this juncture is so little curved that the station lines run quite close together. I also suggested you just trace as best you can, but also keep in mind that some of the station lines you traced would be less reliable than others. It is at this point that we run into trouble with our waterlines.

As I place vertical construction lines at the intersections of the station lines and waterlines on the body plan, I become aware that a station line was more a matter of guess work than tracing. I am not sure I want to project this guesswork into the waterline if I don't have to. My approach is to ignore a station line that is guesswork. Because this normally takes place where the curvature of the hull is slight, the spline tool will make a better "guess" than I could about where the intersection should be. The key is to keep straight which station lines you are using and which ones you are ignoring.

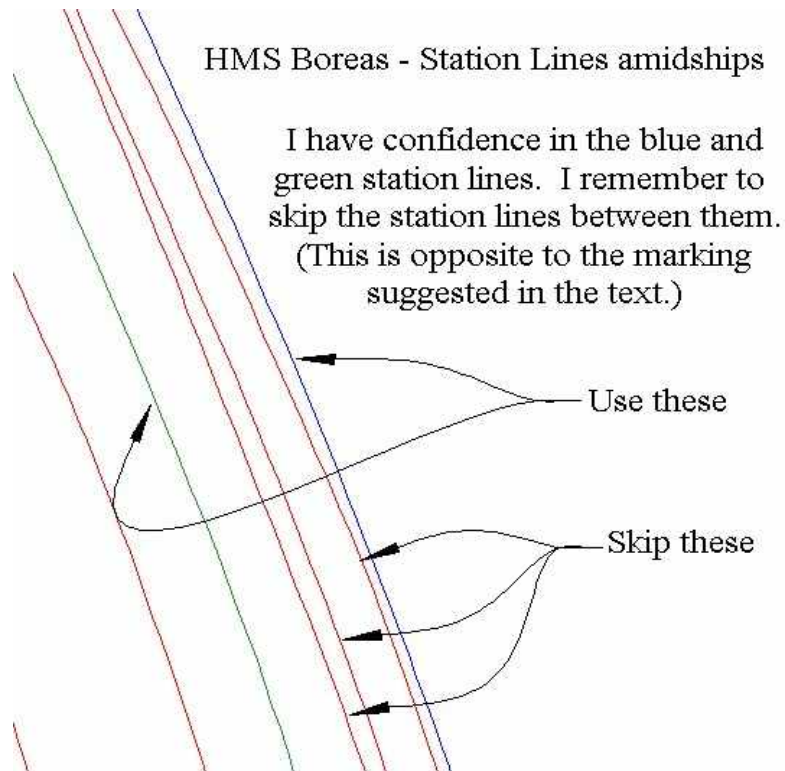

This problem normally shows up at the mid-ship area above the wales. The strategy I have suggested should get you past this inconvenience well enough. Actually, when I ignore a station line, I sometimes mark it by a different color just to help me remember to skip it when setting out points for the spline tool.

Keep in mind that a station line on the body plan may be perfectly clear and useable below the wales but become impossible above the wales. In this case, I use the line for the lower waterlines and ignore it for the upper areas of the hull. In other words, I only use the part of the station line in which I had good confidence when I traced it.

Also, if you skip a station line on the left side of the half breadth plan when setting down the polyline as a marker, you must skip that station line as well when you trace over the polyline with the spline. Otherwise, you will distort the curve of the waterline.

**The cap rail** will show up on the half breadth plan as a kind of waterline. We know that it is not parallel to the keel, but it needs to be drawn in.

While the height of each frame is indicated on the body plan, it is the profile plan that governs the final height of each frame. For this reason, the height of each station line on the profile plan must be transferred to the body plan. By now you know there are no difficult tasks in CAD. We simply place a horizontal construction line on the profile plan where the station line and the cap rail meet. Then we either

extend or trim the corresponding station line on the body plan to the height indicated by the horizontal construction line. We do this for each station line on the body plan. As a result the body plan now indicates the true height of each station.

Now the cap rail line can be drawn in on the half breadth plan. We use the same procedure as for the waterlines except that our vertical construction lines are placed on the top of each station line (in which we have confidence). The beginning and ending points are given by the points on the profile plan where the cap rail begins and ends and are projected onto the half breadth plan with horizontal construction lines. The points of intersection are connected with the spline tool.

This is the simplest way to describe the cap rail. If your ship has a beak head bulkhead or a squared stern then the cap rail will begin and end rather abruptly. That's fine, it is to be a reference line, not a work of art. Also, wherever the cap rail shoots upward (i.e., changes height abruptly) the cap rail line on the half breadth plan must show a break reflecting the change in height.

### The Buttock Lines

For our purposes, buttock lines will help us define the shape of the hull below the lowest waterline. If you look at the body plan, you will note how the station lines can have a rather interesting curvature to them between the keel and the first waterline. Since we will be drawing our frames with the spline tool using points of intersection, it is evident that at present we have only two points in this vital area, one at the keel and the other at the first waterline. Particularly in the mid-ship area we need more definition. The buttock lines give us more points with which to define the hull.

The same process that drew the waterlines is used for drawing buttock lines. The difference is that the buttock lines are projected onto the profile plan to the right of the body plan.

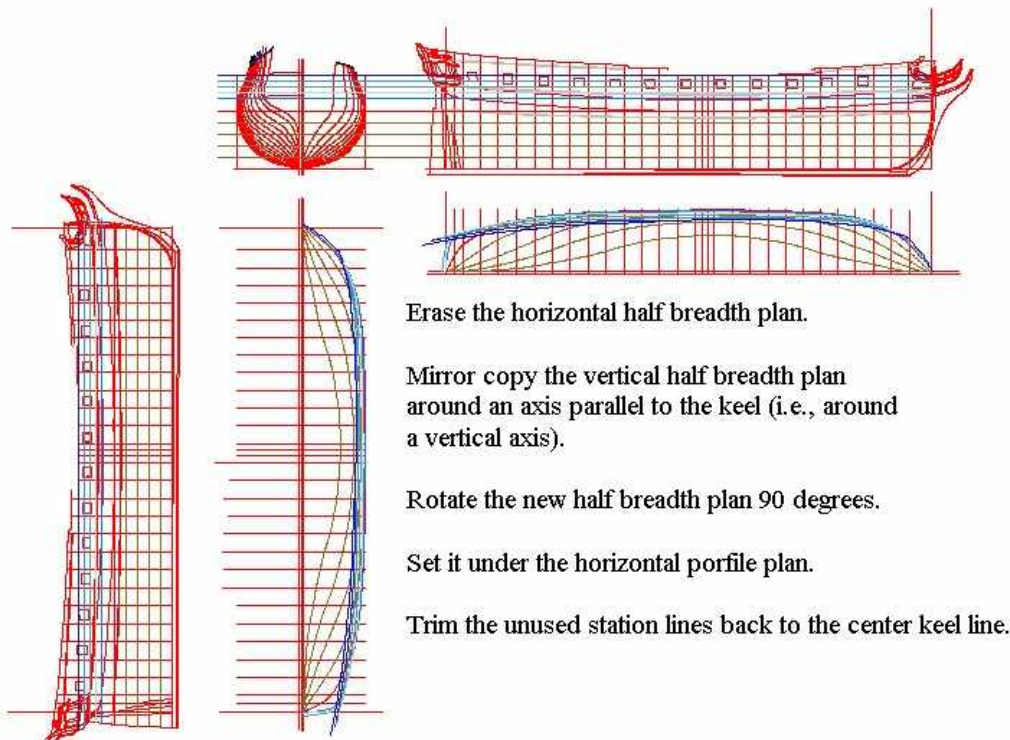

**A copy of the half breadth plan** needs to be placed underneath the profile plan lying to the right of the body plan. Right now we have two half breadth plans, one running horizontally and the other vertically. It was onto the vertical half breadth plan that we projected the waterlines. The other half breadth plan is rather barren by comparison. We will need the information in the waterlines for drawing the buttock lines so our next step is to place a copy of the waterlines onto a half breadth plan below the horizontal profile plan to the right of the body plan.

Perhaps the easiest way to achieve this end is to begin by deleting the horizontal half breadth plan. It was drawn originally as the basis for the vertical plan's development. We will replace it with a copy of the vertical plan. After the horizontal half breadth plan has been erased, select and copy the vertical plan. This copy is then rotated 90 degrees so that it is horizontal and has the bow to the right. You have the option here of placing the waterlines either above or below the keel line. If you have followed my course of action thus far, your waterlines are resting below the keel line, which will work just fine. However, if you prefer you can place the waterlines above the keel line by selecting the horizontal plan and then scaling the Y-axis by  $-1$ . This tells the computer to "flip" the plan around the horizontal plane. (An alternate way to "flip" the plan is to mirror copy itself around an axis parallel to the keel line.)

The new horizontal half breadth plan is aligned with the profile plan (to the right of the body plan) by a familiar method. We place a vertical construction line on top of the profile plan's forward perpendicular and then move the horizontal half breadth plan so that its forward perpendicular line rests on top of the vertical construction line. As a result we now have an identical set of waterlines below the body plan and underneath the horizontal profile plan onto which we will be projecting the buttock lines.

**Think about this** for just a moment. When you were tracing the station lines on the body plan, you will remember the difficulty of tracing the lines close to the keel. I suggested at that time that you just do the best you could, but I also suggested that you keep track of which lines you could trace with confidence and which lines were too much guess work. You may have marked the guesswork lines with a different color, for example. Now is the time to let the guess work go. Because most of the problematic area is next to the keel at the mid-ship area, we just don't need as many points of reference at this juncture. I propose that we use only the lines in which we have confidence as we establish the buttock lines.

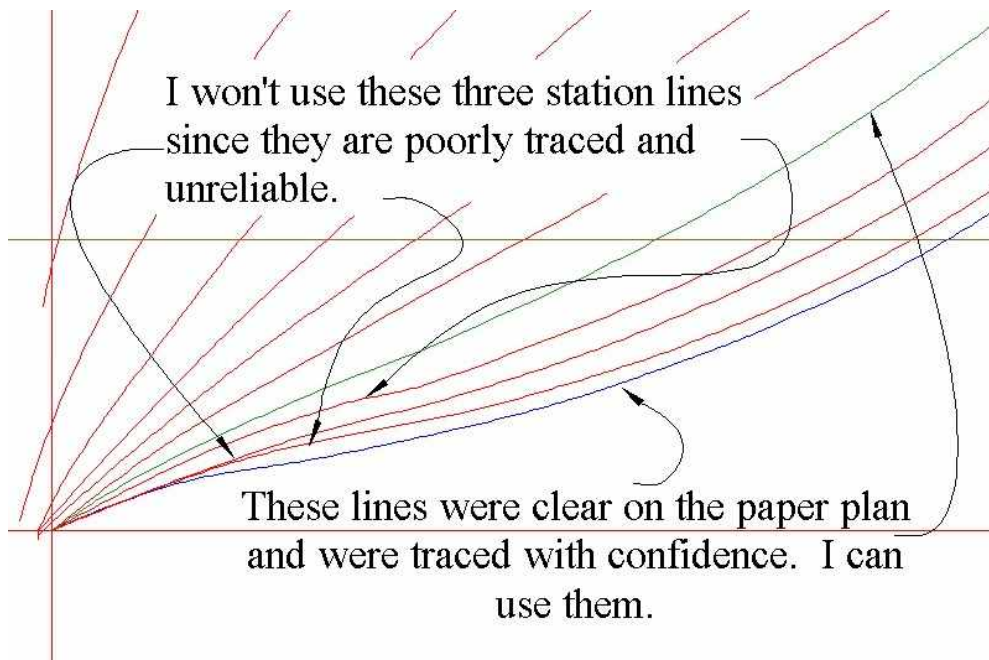

On one drawing, just to illustrate the point, I have confidence in the outside station line. This is to be expected. The next three lines, however, are totally unreliable. The fourth offered a clear tracing, the fifth was indistinct, and the rest were clear. This would be fairly typical. Most of the uncertain lines will fall on stations close to the mid-ship area. So, I can put the uncertain lines in a different color (gray is nice, kind of a nebulous tint) to remind me to ignore them as I project the buttock lines. This is why just doing your best when you were tracing turns out to be good enough for our purposes.

**On the body plan** the buttock lines are a series of vertical lines parallel to the keel. Their number and distance apart can be anything we choose. Again, a lot of lines gives us a lot of points for drawing but also gives us a significant headache. Too few lines don't help us enough. A hull with only a slight curvature below the first waterline doesn't need as many points of reference as does a hull with a drastic

series of curves near the keel. Use your best judgment in deciding how many buttock lines you are going to draw. I will point out, though, that I won't be drawing buttock lines any farther out from the keel than a bit less than the distance at which the outside station line intersects the first water line.

The centerline of the keel is the line of reference for the buttock lines. Either a parallel line tool, linear copy command or an offset tool can produce for you a set of lines parallel to and equidistant from the centerline of the keel. A distance of two or three feet is probably adequate depending on the amount of curvature you will be describing. The more curvature the more lines you need and therefore the closer the buttock lines should be to one another.

Buttock lines on the half breadth plan also show up as a series of lines parallel to the keel. Whatever number and distance you choose for the body plan, use that same number and distance to draw buttock lines on the half breadth plan (the one horizontal and to the right of the body plan). Again use the parallel line tool or linear copy command to produce lines parallel to and equidistant from the center keel line on the half breadth plan. Thus, if I drew lines spaced two feet apart on the body plan, the buttock lines on the half breadth plan must be spaced two feet apart as well. Be doubly sure you use the center keel line for both plans as the reference line.

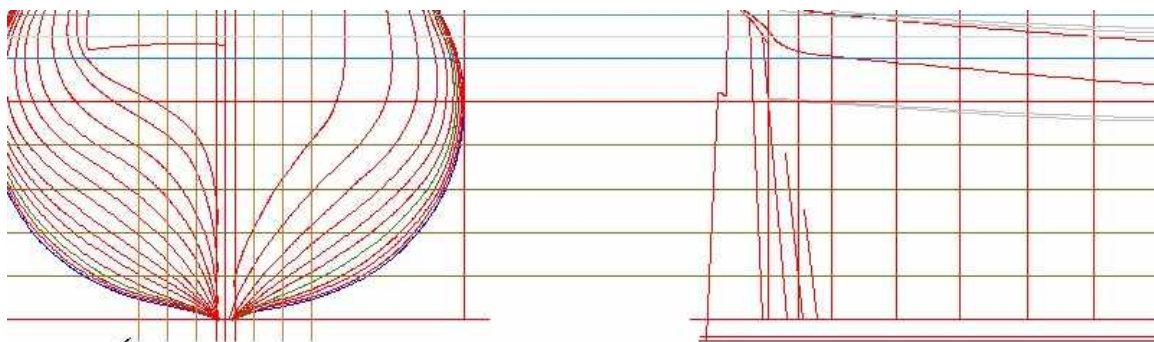

On the Body Plan and Half Breadth Plan  
the buttock lines are straight lines parallel to the keel  
and are equidistant from the keel centerline.

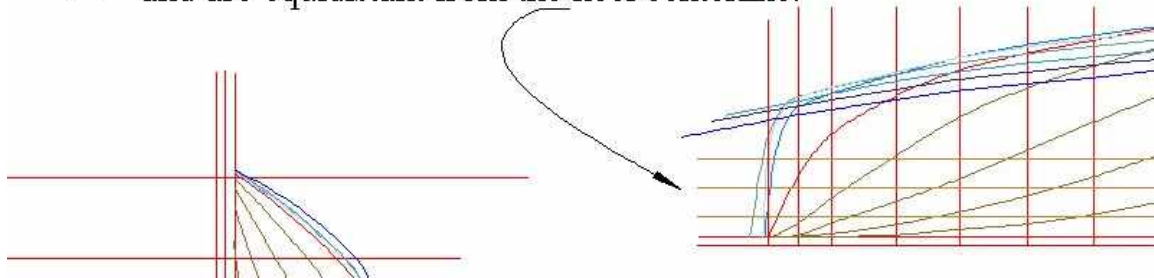

The body and half breadth plans each have a series of straight buttock lines on them. They will now be used to project buttock lines onto the profile plan.

**The first buttock line** (closest to the keel) occupies us first. Turn to the body plan. The first buttock line is represented by both (yes, both) of the vertical lines we just drew in closest to the keel. The left line indicates the after part of the buttock line and the right side the forward part. We start with the after side on the left half of the body plan.

Wherever the buttock line crosses a station line on the body plan we place a horizontal construction line. As happened before, we need use only the station lines in which we have good confidence based on our tracing process earlier on. Moving to the profile plan we see that the construction lines intersect their station lines. If we connect these intersection points we will be defining the buttock line. Once more we use a polyline to connect the dots, as it were. Remember to put a tail on the polyline to make it easier to erase later on. The horizontal construction lines can now be erased.



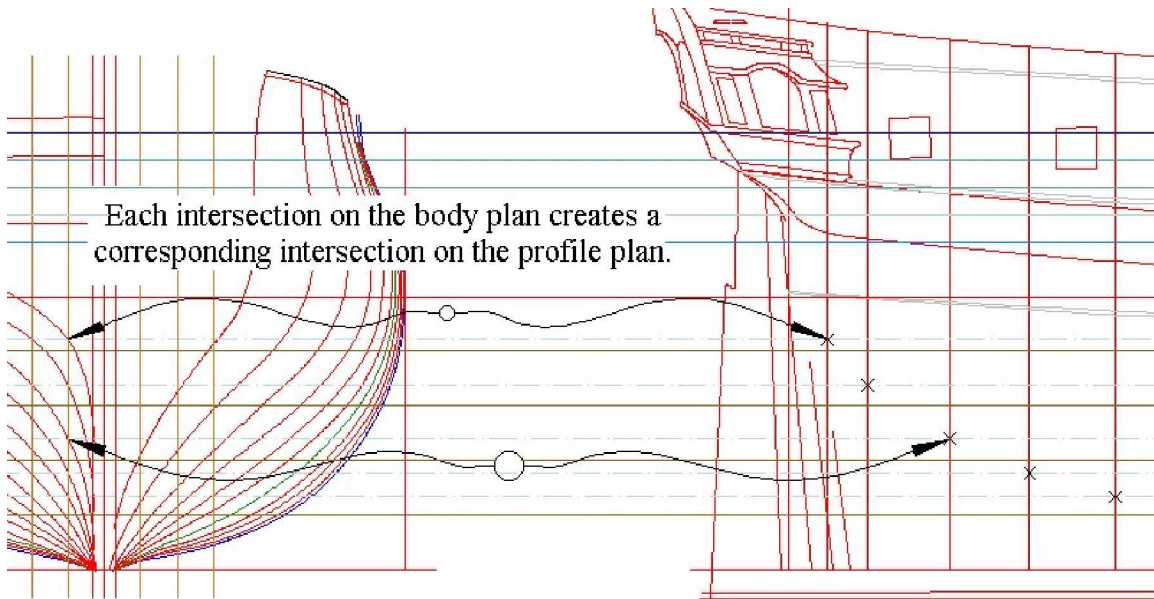

The right side of the body plan (the forward part) is treated the same way. A horizontal construction line is placed on each intersection of a station line with the vertical buttock line on the body plan. We have one more preparatory step before drawing in the final line.

Right now, our intersection points (indicated by the polyline aft and the construction lines forward) begin and end at a station line forward and aft. For the sake of completeness we may want to run the buttock line further. To do so, turn your attention to the (horizontal) half breadth plan and find the intersections of the waterlines and the buttock line in the areas forward and aft of the station lines. Place a vertical construction line at the intersection of the buttock line and the water lines. I would only use the water lines up to the level of the wales. If you follow these vertical lines upward you will see that they intersect the corresponding waterlines on the profile plan. Again, each intersection point lies on the buttock line we are drawing.

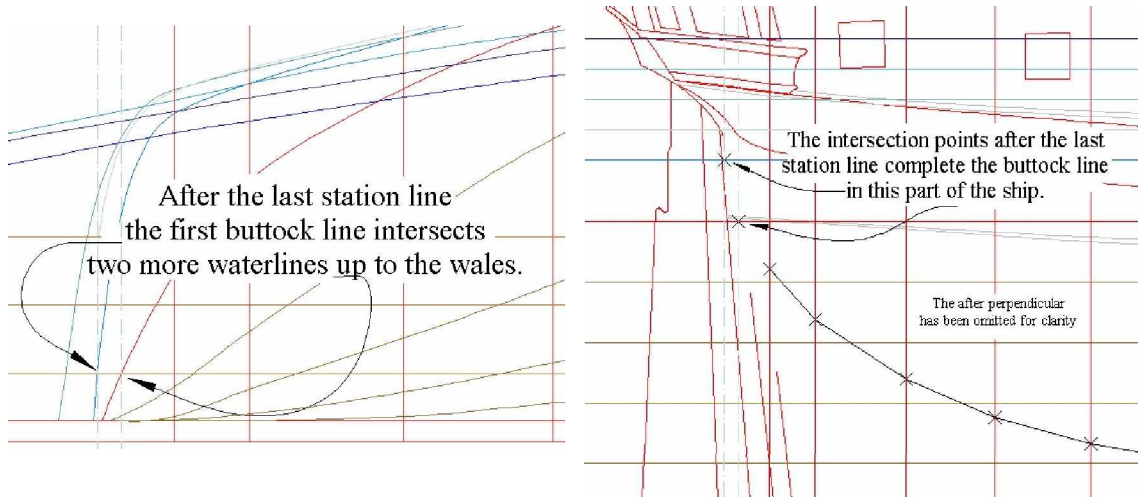

Once more we have a multitude of construction lines, but they make sense to us as we refuse to panic and proceed with care.

The spline tool with the intersection snap mode engaged will draw out the buttock line. We begin at the stern on the profile plan where the after most vertical construction line intersects the appropriate waterline (i.e., the waterline that determined its position on the half breadth plan, but you knew that). We

then follow the intersection points of the other vertical construction lines (how many depends on the hull shape) until we reach the station line where the polyline begins. From that point we follow the polyline (remembering to ignore station lines we had deemed uncertain earlier on) until we reach the end of the polyline. Our connection then follows the intersections of horizontal construction lines and station lines until we reach the final station line (ignoring uncertain station lines for which there should be no construction line). At this point we use the intersections of vertical construction lines and waterlines in a manner similar that what we did at the stern. The spline is finished off when we reach the waterline we decided upon as the highest point for our buttock lines. Of course we now delete the polyline line and all construction lines, leaving us with our nicely curved buttock line, something people have wanted for years.

This is as simple as drawing waterlines, a process mastered already. In theory we could continue the buttock lines all the way up to the cap rail if we liked. For that matter, we could draw buttock lines all the way across the hull. But our purpose for drawing buttock lines is to define the shape of the hull below the lowest water line, and so we will be content with just three or four (maybe five) buttock lines next to the keel.

**The other buttock lines** are drawn in with the same procedure. Their greatest utility will come at the mid-ship area, but having them sweep from stem to stern adds a touch of elegance to the drawing.

### The Station Lines

Of the three kinds of lines that define the shape of the hull, you have drawn out your own waterlines and buttock lines. Only the station lines remain as traced entities from the original paper plan. The other traced lines that remain define the shape of the keel, the height of the frames, and the sweep of the decks and wales. But the waterlines, buttock lines, and station lines give the basic shape of the hull. We did not even bother to trace the waterlines and buttock lines, choosing to rely on the station lines of our original plan for guidance. A visual comparison of the waterlines on the original paper plan and our CAD waterlines should show them to be quite similar. If you have buttock lines on your paper plan, you will probably find them similar to what you have just drawn in as well. It remains for us to draw our own station lines.

**Irregularities on the waterlines and buttock lines** must first be worked out.

A waterline should be a long graceful curve reflecting the efficient displacement of water as the hull moves along. Common sense tells us that a “bump” or “dip” in the line must represent a flaw in the waterline. You can, if you like, imagine you are holding the solid hull in your hands and feeling along the hull for raised spots and depressions. A high spot on the hull would be seen on the waterline as a bump outward; a depression would appear as a dip inward by the waterline. On the solid hull we would sand the high spots down and fill the low spots in with some kind of filler or putty. In CAD, we simply manipulate the offending spot on the line until it runs smooth and true, that is, until it runs fair.



The second waterline needs to be adjusted, in this case inward.

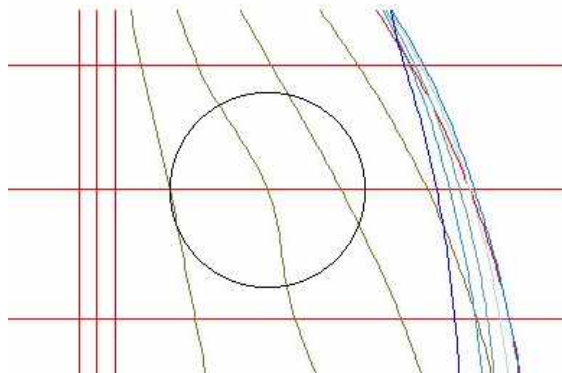

Finding the places that are out of fair is a matter of sensitivity and judgment. I suppose we could speak of the maxima and minima of the curve and their relation to one another, but that is beyond me to describe. I would instead invite you to look at the lines for places that don't look quite right. For example, a smoothly running concave curve takes a convex shape at just one station and then returns to a concave shape again. This probably indicates a place that needs fixing. Or it may be that a gentle curve veers widely at one station compared to the neighboring stations. This again probably needs fixing. Try to identify such

places on your waterlines and buttock lines.

There are a couple of ways to fair up an errant waterline. One is to edit the spline nodes, the other is to let the computer do the job for you.

When you drew in your curves using the spline tool, you were actually setting down points, called nodes, that defined the curve. Imagine for a moment that you have a flat sheet of plywood onto which you want to draw a curve. You could set nails into the plywood along the path you want the curve to take and then bend a thin strip of wood around the nails. To get the wood strip to bow out or in you could tie to the strip a string attached to a weight hanging over the edge of the plywood. Depending on the weight, the strip would bow either more or less. This is close to what a traditional draftsman might do to create a curve using a spline of wood, set pins and weights. CAD does the same thing in the computer with nodes doing the work of the nails.

The help topics and reference manual for your CAD program will tell how you edit the node placement of a spline curve. Once you have selected the waterline in question, you could move the misaligned node to a position that causes a better run of the curve. In real world measurements, I doubt you will be moving the node more than an inch or two.

Another way to fair up the line would be to retrace the entire waterline by clicking at each station but skipping the station with the out of place segment. In effect this asks the computer to guess at the proper location for the curve.

Either method is adequate. The buttock lines should be analyzed and faired in the same manner as the waterlines. On one plan with thirteen waterlines and buttock lines I found only three places that needed this kind of treatment. A reasonably good paper plan should yield a reasonably faired tracing of the body station lines, which should lead to waterlines and buttock lines that are pretty much fair to begin with.

We have a faired set of waterlines and buttock lines. We are confident in their description of the shape of the hull. Now we are in a position to redraw the station lines on the basis of our work thus far.

**Erasing the station lines** may seem a bit drastic, but it is the next step. Right now the station lines are traced lines with the all the accuracy of a human endeavor. We can erase the station lines and replace them with computer generated lines that are perfectly uniform in spacing. A word of caution is in order. We are not yet drawing in frames. The station lines are references for the shape of the hull. On some ships the station lines may coincide with a frame, but then again they may not. We are drawing them in order to complete the basic lines drawing of our ship. We will also inspect our new station lines for bumps and depressions as a part of the fairing process.

Take a deep breath and erase all the station lines on the body plan that you labored so hard to trace. You should be left with the keel lines (center and side), the perpendiculars defining the breadth, the buttock lines, and the waterlines extended over from the profile plan.

Station lines on the profile and half breadth plan will also be erased, but not before we have marked out the dead flat area of the hull. On the paper plan, there is a station line that falls on that portion of the hull where the sides of the ship are essentially parallel to the keel (or flat). It may be marked with "CL" or a special symbol. If you are in doubt, identify the label of the outside station line on the body plan and find the corresponding station on the profile plan. Do this for both the right and left sides of the body plan. The dead flat station will fall between these two stations.

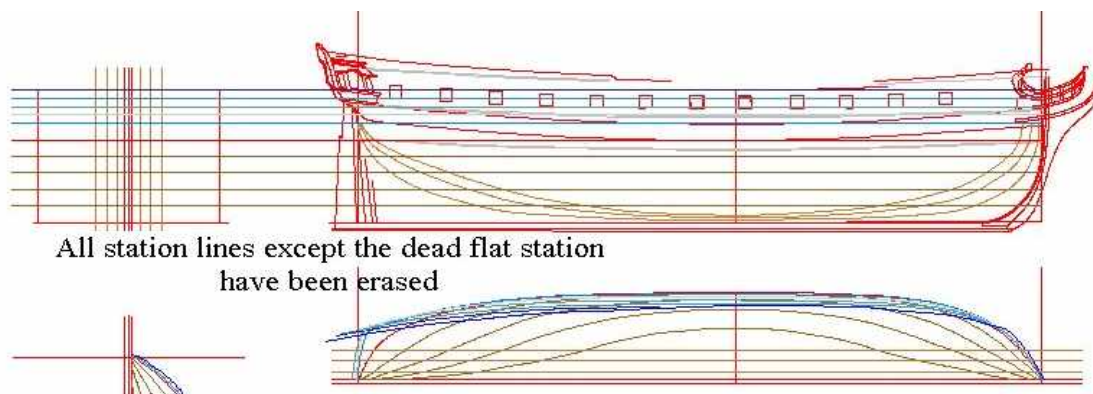

(Before you proceed, take some time to measure the distances between the traced station lines on the profile plan. Record this data somewhere. Why I'm asking you to do this will be clear in just a moment.)

On the profile plan all the station lines except for the dead flat station should be erased. This is also done on the half breadth plan, leaving only the dead flat station line with the waterlines and buttock lines. Perform this erasure on both the horizontal profile and half breadth plans.

We have erased the station lines so that we can draw our own lines onto the plan.

**A similar process** is used for drawing station lines as we used before. Both the waterlines and buttock lines used a series of construction lines to define points of intersection. We drew in a polyline to indicate half the curve. Then we used a spline to create the curve we wanted using both construction lines and the polyline to indicate the intersection points to be connected. After erasing the polyline and construction lines we had our curve. We will employ this same method for drawing the station lines.

**We begin** by drawing station lines on the profile plan. These will be perpendicular to the keel and spaced equidistant from one another. The distance between them is up to our judgment, but I may suggest that we mimic the distance on our paper plan. This can be found by measuring the original plan with dividers and a good scale. The other option is to use the measurements we took just a moment ago. I doubt that the traced station lines were uniformly spaced, but they were probably close. Assuming this is the case, select a distance close to the average distance from your measurements. For convenience you may want to round the number to some basic interval such as on the foot or half-foot.

Starting from the dead flat station line, draw in a series of lines parallel to the dead flat and perpendicular to the keel at the distance you have determined. Do this moving both forward and aft. For instance, if I want stations every five and a half feet, I will have a station line set down every 66 inches. I will stop placing station lines before I move past the forward and after perpendiculars. Of course both profile plans on my drawing area must be treated this way with the same distance of separation. Having two profile plans requires this double work, but it is essential that they remain identical. Because CAD can draw in the station lines with unerring accuracy, we know that the two plans are identical.

Now the half breadth plans will have station lines placed on them. There are a number of ways this can be accomplished, but for now I might suggest repeating the same steps as you just performed on the profile plans. Begin with the dead flat station (that you left from your tracings) and set down lines at the same distance as you used for the profile plan.

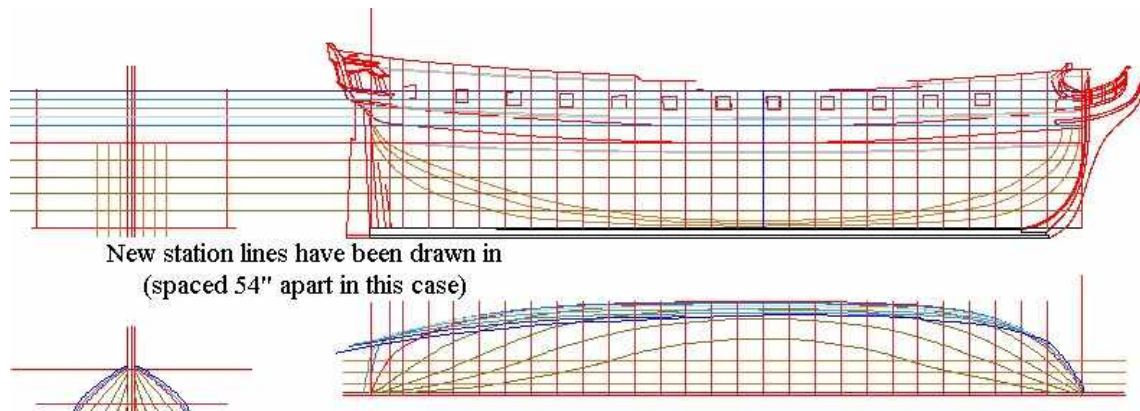

New station lines have been drawn in  
(spaced 54" apart in this case)

There, you have station lines on two out of three drawings (or four out of five, depending on how you count them). With our experience drawing waterlines and buttock lines we have no consternation about drawing station lines on the body plan.

**The following method** for drawing station lines is so important, I hope you will make sure you have completely mastered it. Already you are on your way, for it is no different in principle than what you have done previously. It is important because you will use this method for lofting out the frames when the time comes.

Let us work on the station line just forward of the dead flat. Remember that the forward station lines are drawn on the right side of the body plan with the after stations on the left side. Thus, we will be drawing our line on the right side.

The profile plan to the right of the body plan gives us the intersection points of the buttock lines below the first water line. A horizontal construction line placed on the intersection of the station line and the first buttock line (which is curved on the profile plan) will extend over to the body plan. On the body plan this construction line will intersect the first buttock line (which is a straight vertical line on the body plan). The intersection of the construction line and the buttock line is our first point on the new body station line. A set of construction lines placed on similar points on the profile plan will create a set of intersections on the body plan with the buttock lines. These intersections can be marked with a polyline (as we have done before) remembering to extend a tail away from the plan. Now that the polyline defines the curvature of the station line below the first waterline, we can delete the construction lines.

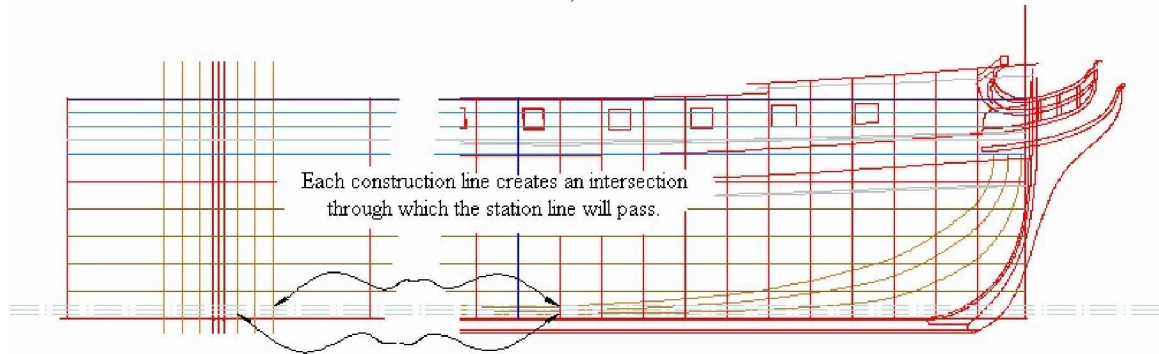

The vertical half breadth plan below the body plan gives us the intersection points with respect to the waterlines. Vertical construction lines are placed along the station line at the intersection of the station line and the waterlines. However, and this is significant, only place construction lines for the waterlines below the wales. We are going to work with only half the station at a time to simplify matters a bit. As a result you should see a set of vertical construction lines extending up across the body plan.

At the points where a construction line on the body plan intersects its respective waterline (that is, the same waterline that determined its position on the half breadth plan) we have a set of intersections defining the shape of the station line below the wales. These intersections must be marked with a polyline in the familiar manner, again with a tail off to one side. This being done, the construction lines can be erased. You must recognize this as the same procedure we followed for drawing waterlines, only done in reverse.

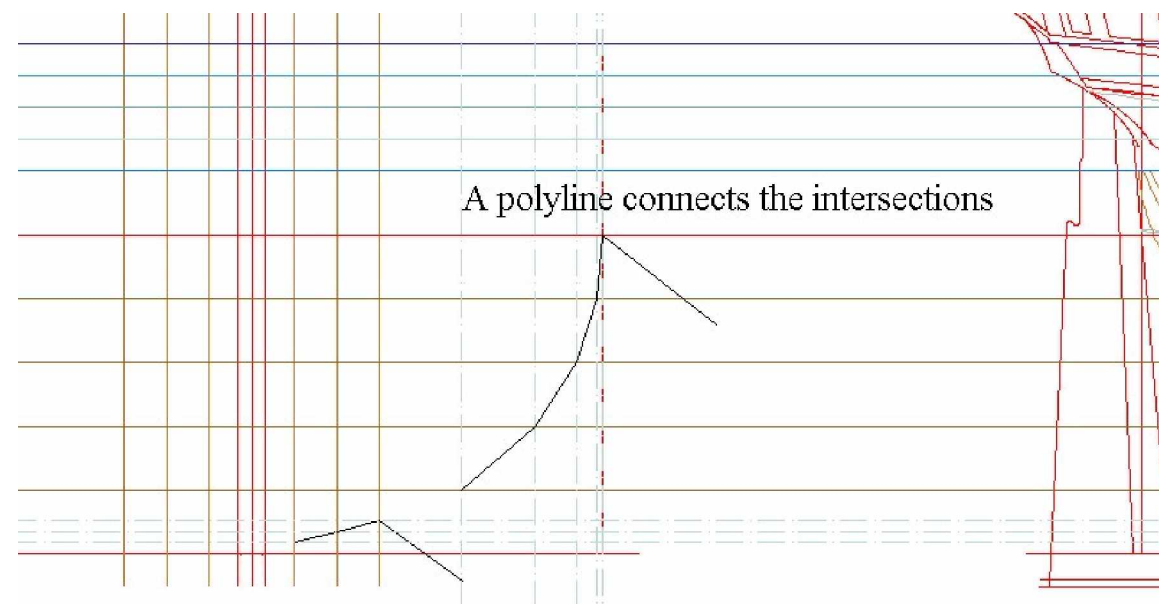

Now we repeat the process with construction lines indicating intersections with the waterlines above the wales. We also place a construction line on the intersection with the cap rail line. As an added step we return to the profile line and place a horizontal construction line on the intersection of the station line with the cap rail.

The intersection points on the body plan between construction lines and respective waterlines can now be marked with a polyline. The polyline will end at the intersection of the horizontal construction line and the vertical construction line defined by the cap rail on the half breadth plan. Again, all construction lines can be erased as soon as we have marked the intersection points on the body plan.

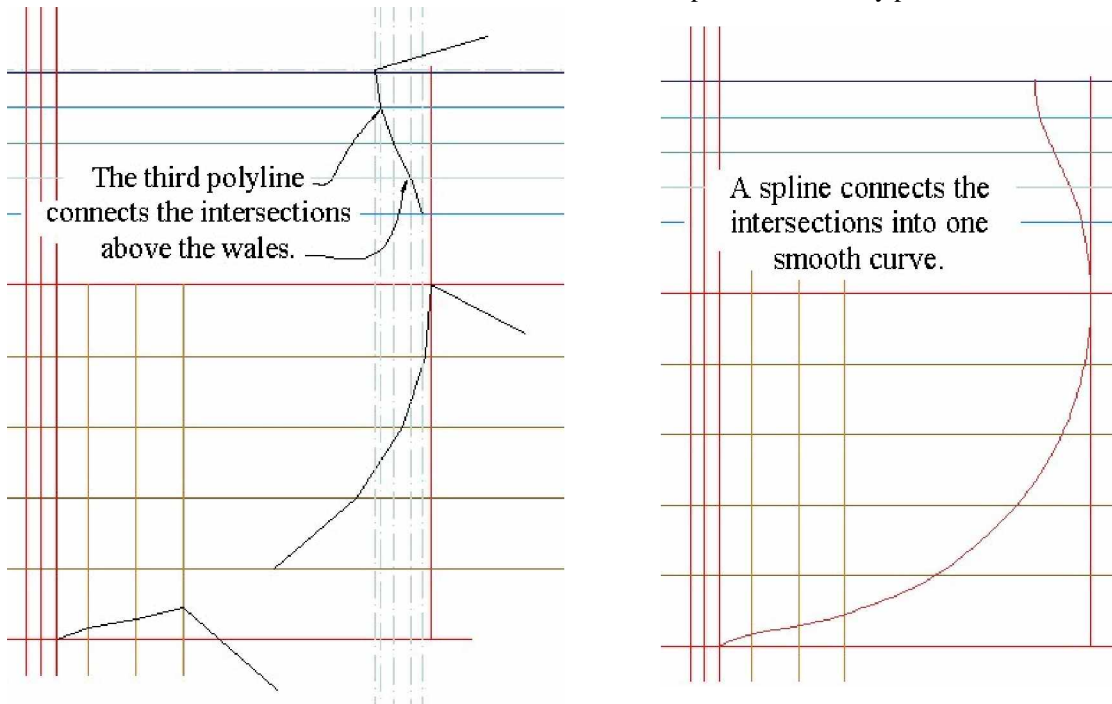

It is now a simple matter to trace a spline through the points marked by the polylines to form the curve of the station line. Begin at the keel where the side of the keel is intersected by the keel line. From there continue to click on the places indicated by the polylines until you reach the cap rail. Finish off the spline and you have drawn the station line. The polylines are erased, a step made easier by the tails off to the side. We are left to admire our station line in all its graceful beauty.

Drawing the line in three steps like this avoids a tangled confusion of construction lines that would be all but impossible to keep straight. If you are really (and I mean really) good you might have done the work in one step without the polylines, but my life was easier when I broke the process down as I have suggested.

Once you are adept at this method, there are a couple of ways you might expedite the process. The first two polylines can be combined since the horizontal construction lines of the buttock lines and the vertical construction lines of the waterlines will not run into confusion with one another. Thus, draw both sets of the construction lines and join the intersections with just one polyline. This being done, the third polyline can be bypassed altogether. Set out the third set of construction lines (above the wales). Then use the spline tool to join the polyline intersection points with the upper construction intersection points in one final curve. I gave the more tedious approach first to lay out the method. Certainly every person will find ways to improve upon it to their own advantage.

**The keel line was used** as the starting point for each station since this is the case for the vast majority of station lines. At the bow, however, there may be one or two station lines that rightly begin higher up. You will recognize them on the profile plan as stations that intersect the upward sweep of the rabbet before reaching the level of the keel line. In these cases, project the starting point with a horizontal construction line set on the intersection of the station line and the inside of the rabbet. On the body plan, the station begins at the intersection of this construction line and the side of the keel.

At the stern we will not have this situation quite as much, but we will want to pay attention to the issue. If a station line at the stern intersects the sternpost before contacting the keel line, the beginning point for that station will be projected with a horizontal construction line.

**Examine your new station line** for bumps and depressions. This is a matter for a judgmental eye and a sense of what is fair. Should you think adjustment of the station line is needed, you can do so in the same manner as you did for the waterlines and buttock lines. However, you will want to adjust the appropriate intersection with the waterline (or buttock line) so that the two lines match. A high or low spot

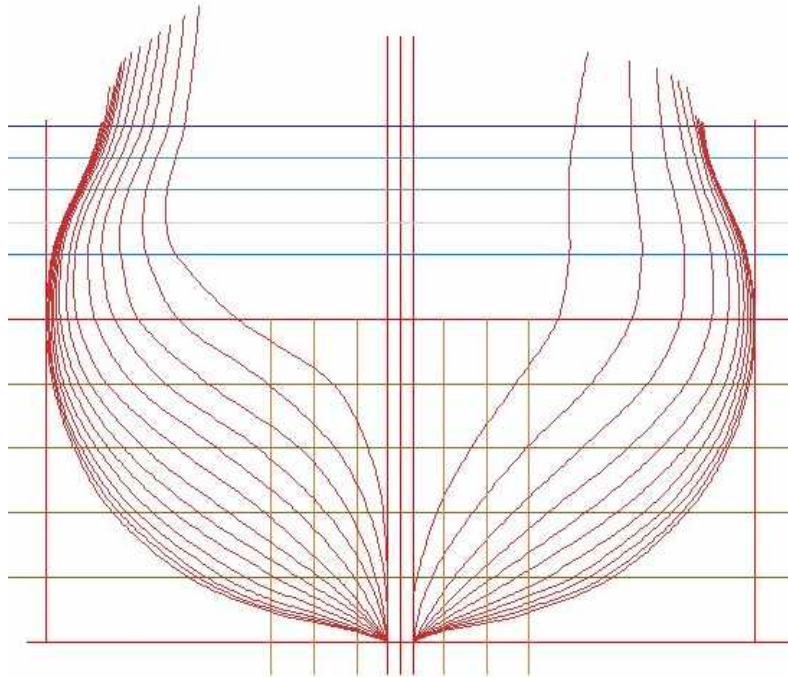

in one line will mean there is something to be adjusted in the other line as well. If you have faired up the waterlines and buttock lines before starting the station lines, there should be a minimum of changes. On a good day you may need none at all.

**For each station line** this procedure is repeated. When dealing with the after station lines, you will work on the left side of the body plan. The problem is that all your waterlines are on the right side of the half breadth plan below the body plan. The solution is easy enough, just mirror copy the waterlines around the keel centerline as the axis. This will set an identical (mirror)

set of waterlines on the left side of the half breadth plan. Now you can proceed with projecting the after station lines to the body plan on the left side. Once all the station lines are drawn in, you can join the topmost part of the lines to indicate the sweep of the cap rail on the body plan.

### A Fair Plan

Our work thus far has been largely a matter of projecting points of intersection from two plans to the third plan. I think we can be justly satisfied with the results; but there is one more important task before we can rely on our drawing.

**A perusal of the body plan** might reveal a few troublesome areas. This is to be seen when a station line seems to interrupt the natural progression of lines. It may seem too close to another station line, for example. This is not so much a matter of a bump or depression, which we have already looked for, as it is a question of a station line that just doesn't look quite right in relation to the lines around it.

So, let us suppose we have discovered a place on the body plan that requires attention. Here's what we do. First, we must remember that a body station line that is in error will mean that a corresponding waterline also needs some kind of adjustment. Manipulating one will require an equal manipulation of the other. For this reason, if I adjust a body station line at the level of the third waterline, I will need to project that change down to the half breadth plan so I can move the third waterline. The process is the same as when we were drawing waterlines on the basis of our traced body station lines. A vertical construction line is placed on the intersection of the altered station line and the waterline. On the half breadth plan, we retrace the waterline in question, but we use the new intersection instead of the old in order to match up with the adjusted body station line. Here's the headache. You must adjust every instance of that particular waterline. This is not so hard as I make it sound, for it is a simple process of erasing the old lines and putting copies of the new waterline in their place.

Actually, I doubt you will be moving lines any more than an inch or so (in real world measurements). You may want to ask yourself if you could hew out a timber to a tolerance of tenth of an inch with adze, for that's what we are talking about. Certainly, obvious diversions from a fair run of station lines must be changed. On the other hand, I'm not sure I would lose too much sleep over a quarter inch.

**You have a complete set of lines** in your computer. The three plans have been reconciled to one another in the fairing process and we have confidence in the results. Now we are in a position to begin lofting out the members of the ship. First, we will create a framing plan to indicate the placement of the frames. Then we will draw out the keel and related timbers. Next we will loft the frames including the floors, futtocks and top timbers. The angle for any beveling of the frames will also be indicated by the lofting process. None of this has been hard when taken step by step. Lofting out the ship's members will be equally straightforward.

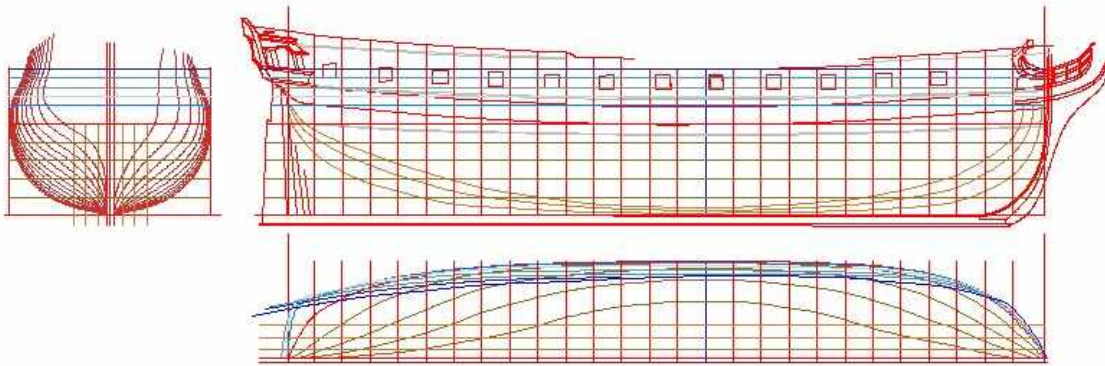

Save your work in a separate file at this point. For future steps, it is a good idea to open the lines plan you have just completed, rename it and then proceed. For example, the next task before us is to create a framing plan for our ship. Open a copy of the lines plan, rename it (something like "Framing Plan") and work with that. Because CAD is able to make perfect copies, we do not have the traditional problem of creating (or tracing on paper) a new plan.



## The Keel Plan

The keel plan will set down the fore and aft members of the ship's structure. Had we been an architect, we would have started with laying down the keel as the most important element giving strength to the vessel. In our plan, we already have the keel line laid down, that is, the top of the keel. We have also traced the knee of the head, the sternpost and the forward rabbet. These we will retain in the final drawing. However, we want to create new lines for the bottom of the keel, for the false keel, and for the internal fore and aft members such as the sternson, keelson, stemson, deadwood, etc.

### The Keel

The keel itself is the foundation for all other construction on the ship. Its dimensions are determined by very strict rules depending upon the era, the type of ship and nationality. Finding the rules for your particular ship is up to you. I am going to offer the dimensions I have for my little ship, for you will learn the basic principles easy enough. They will apply to any vessel once you have the idea.

**The top of the keel** was the first line we drew in. We did not exactly trace it, for we let the computer ensure it was a straight line. We used the paper drawing to set the position of the bottom of the keel along with several other important elements. Now it is time to draw in the keel lines with as much precision as our knowledge of shipbuilding practice will allow.

Let us say that my keel dimension is to be 14 inches in width. For my ship, the rule states that the keel has the same dimension on all sides. Therefore, I want the bottom of my keel to lie 14 inches below the top (which is my keel line). So, I want to erase the bottom keel line that I traced off the paper plan. In its place I set down a line parallel to the keel line and distanced 14 inches. With CAD this is a simple matter of choosing the right tool (a parallel line tool or offset too, perhaps a linear copy tool, there are many ways to do this) and then entering the appropriate distance. You can also see why using real world measurements is so much easier than performing a scale conversion at every turn.

The forward end of the keel ends in the boxing joint, a complex piece of joinery that is hard to see on a model but satisfying to construct. I have no desire to repeat the literature on how this joint might be laid out, but as you draw out your plan you will allow in the back of you mind that this pleasant work will occupy you when you translate your drawing into wood.

The after end of the keel ends in line with the angle of the sternpost. This angle you traced with a straight line. Use this angle on the new keel lines for the after end.

We are not done with the keel, for it is helpful to indicate the rabbet. This groove in the keel received the garboard strake, the lowest line of external planking. We have used the top of the rabbet for our basic keel line. The bottom of the rabbet will be a line parallel to the keel line and set a several inches down. I have chosen to place it 3 inches below the keel line.

The false keel for my ship is 5 inches in depth. As a result, I choose to set my false keel down as a parallel line 5 inches below the keel.

**The physical structure** of the keel in the model must be decided before we can start transferring our keel drawing to wood. If we use a single stick, all fine and good. But actual practice would dictate that the keel be made up of several pieces joined together with a scarph joint. The number of sections of the keel would also be determined by rules of the day. But let us agree that we want to divide our keel into five sections in keeping with the practice the original builders.

Simple division gives us the length of each section. A keel of 124 feet would have sections of 25 feet each (with one section a foot short). Beginning at the bow, draw a circle (construction circle if you can, normal if need be) centered on the front edge of the keel having a radius of 25 feet. Where this circle intersects the keel draw an identical circle. Do this five times and you have the divisions of the keel. Mark these points with a vertical line across the keel and then erase the circles. Actually, a scarph joint will connect these sections so that the actual members will extend beyond this line to create an overlap of sorts. How this joint is constructed will be covered when we loft out the keel pieces later on. By the way, the false keel would also be built in pieces with the joints offset from the joints of the keel.

### The Stem

The stem rises from the keel at the bow. On my little ship it is a graceful curve. We traced this curve from the paper plan, and there is no way to improve on our work short of learning naval architecture and revisiting the calculations of the original designer. However, you will need to be familiar with how your ship would have been put together to know the way the stem should be constructed on your model. Again, if you will cut it out of just one piece, all well and good. If, on the other hand, you want to replicate actual practice, you will need to know where divisions and joints were placed.

It lies well outside the bounds of this treatise to suggest how you would accomplish this end on any particular vessel. I simply suggest that you must make the decision at this point and draw in the pieces for your stem. You have the outlines provided by your tracing of the original plan. Native intelligence should be enough for you to add the rest. I suspect the joints you add will consist of straight lines, even if you draw in the proper scarphs. Thus, you have sufficient skill in terms of using CAD; the knowledge of where the joints lie must come from your mastery of shipbuilding in general.

**The stempost, apron, rising wood, etc.** will all be drawn in with a combination of straight lines and splines. A glance at a finished drawing of this area of the ship should give you an idea of the elements that go into the drawing. Once you have determined the placement of the various pieces, draw them in outline. Then return to make the joint lines (such as the scarphs).

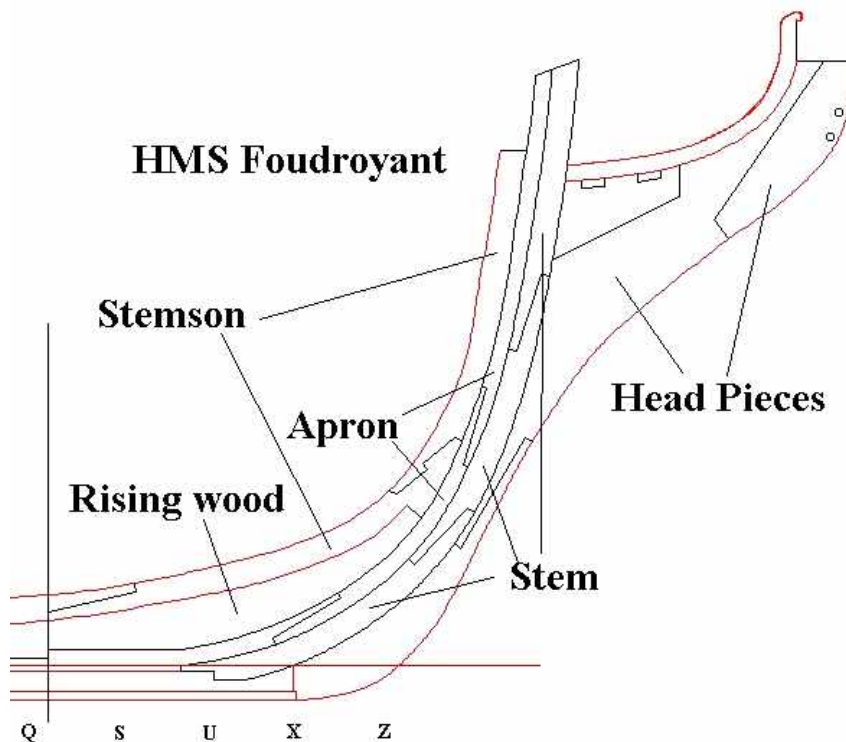

**The question of drawing scarphs** may be reviewed here with good profit. There are many kinds and variations of scarphs in shipbuilding, but there are two in particular that are relatively easy to draw and easy to construct. I should like to offer a method of drawing them in CAD

First, a scarph joint can be thought of as a kind of lap joint. The two pieces overlap one another and so must be cut precisely in order to mate together cleanly. The good thing about drawing in CAD is that the joint line we draw for one of the pieces is automatically the joint line for the other piece. This insures that the joint, if cut out properly, will match up.

Let us first consider a simple scarph joint on two straight pieces since joining two curved pieces is no different in principle. We begin with the observation that a scarph is to be a fifth to a sixth of the length of the pieces being joined. If our keel sections, say, are 25 feet in length, then a joint of 5 feet is about right. To mark out this distance, we use a circle. Placing the center of the circle at the junction point of the pieces, we extend the diameter of the circle to 5 feet (be sure to keep straight in your work the difference between diameter and radius). Where the circle intersects the pieces we have the ends of the scarph. Each

of these ends should be marked with a straight line perpendicular to the side of the piece. We now have the ends and the middle of the joint marked out. The scarph is cut into the piece to a depth of one third the thickness of the piece. A 12-inch piece, therefore, would have a cut depth of 4 inches. Now a circle with a radius of 4 inches is placed at the intersection of an end line and one edge of the piece. An identical circle is placed at the other end line on the opposite edge. The end cuts of the joint follow the end line to the edge of the circle. By joining the intersections of the end lines and their respective circles, we have a simple scarph joint.

When dealing with a curved piece, the process is no different. CAD will provide a way for us to draw an end line perpendicular to the curve (perpendicular to a tangent line intersecting the curved piece at the point of the end line, if you prefer).

A hooked scarph adds just one step more. At the center line of the joint a circle with a diameter of one third of the thickness of the piece is constructed with its center point at the middle of the midline of the joint. The portion of the line inside the circle is the cut of the scarph. I would use a polyline to trace the lines of the joint.

Of course, all the reference circles and line must be erased after the scarph joint line have been drawn in.

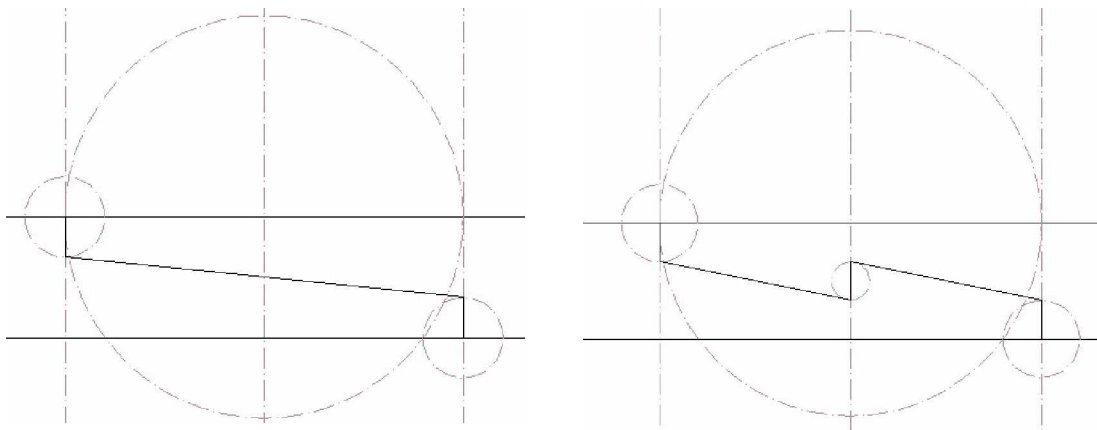

## The Stern

The stern requires the same approach as at the bow. The dead wood is made up of several pieces, their exact disposition being a matter for the shipwright to decide depending on available material. You

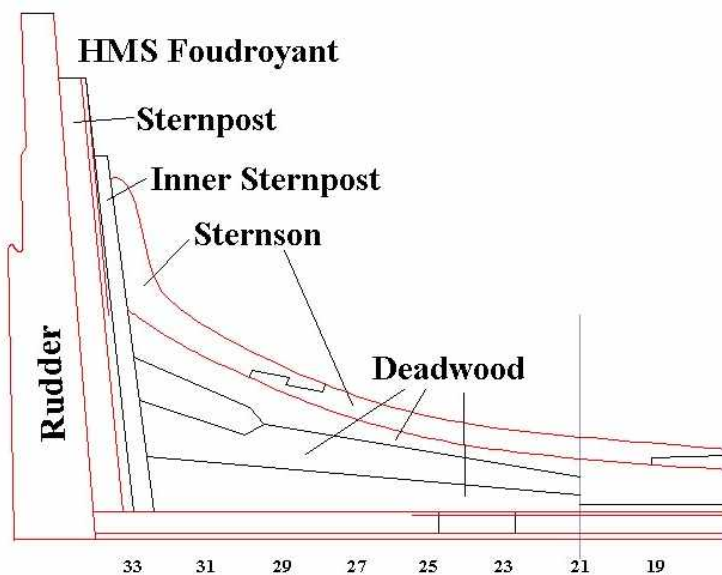

might use a single piece of wood, or you may want to piece the deadwood together with a series of joints. This is a matter for you, your judgment and the historical data you can find. Your goal at this point is to indicate the manner in which the deadwood will be built up when you put knife to wood.

The top of the after deadwood should be a curve and so will require a spline. The other pieces can be indicated with straight lines. If you choose to include a scarph joint you know how to do that as well.

The question should arise of how we know the basic outlines of the deadwood and the

rising wood at the stern and bow respectively. The simplest answer is that your original plan should tell you. When you see an inboard profile of your ship the outlines of the keelson (which terminates in the stemson and sternson at either end) should be drawn in.

If, on the other hand, your sources do not give you the precise line of these members, all I can suggest is that you acquaint yourself as best you can with the practices of the era of your vessel and do the best you can. Another option would be to study naval architecture and learn the formula and rules determining such things. As you do so, however, keep asking yourself if you are having fun. Life is a series of accommodations with reality. One person's compromise is another's common sense. When the information is available, use it. When it is absent, find it. When all else fails, forge ahead and, as Martin Luther is supposed to have said, sin boldly.

## The Keelson

The keelson runs the length of the ship as the extension of the stemson until meeting with the sternson. Since the keelson rests on top of the floor timbers, the line of the keelson depends on our first knowing the height of the floors over the keel. If we have a good original plan the keelson will be indicated for us. Otherwise we will have to draw in the keelson.

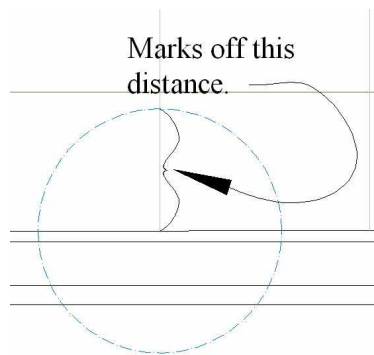

The height of the floor at the dead flat frame should be determined (by measuring the plan or through research of contemporary practice). At the bow and stern the keelson joins the stemson and sternson respectively. The points we set down should be connected with a spline. The upper line of the keelson is at a distance equal to the depth of the keel.

One way to mark a height uses a construction circle with a radius equal to the distance in mind. For example, if you need a distance of 18 inches marked out, placing the center of a circle with a radius of 18 inches at the junction of the station line and the keel marks the height along the station line. The radius set at the determined height means that the circumference of the circle intersects the station line at the height we desire.

## The Drawing

Removing all elements of the drawing not pertaining to the keel itself completes the keel plan. I have been working with a copy of the profile plan to draw in the various elements, but now I can subtract such things as the cap rail, the wales, the station lines, waterlines, etc. The finished drawing is fairly bare, but it is the backbone of our project and merits an equitable amount of attention.

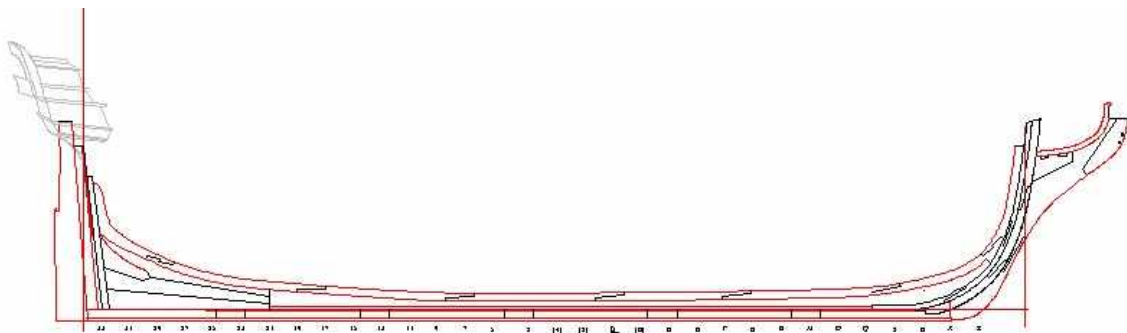

## The Framing Plan

Before we can loft out the shape of the frames, we need to know exactly where they will be placed. This is the function of the framing plan. Complete framing disposition plans are not always available, but we should be able to put together a viable plan even without one. On the other hand, you may have the original framing plan in front of you. Your research will have given some sense of the “room and space” for your framing, that is, the thickness of the frames and the amount of space between them.

On my little ship I have been fortunate enough to have a framing plan from the original designer. So, if my goal is to reproduce the exact framing I am all set. On the other hand, most models make some compromise with actual building practice. For instance, the width of a frame (the siding) decreases on my ship as it rises. This can be done on a model to be sure; but it is a matter of taste and stamina as to whether it is entirely worth the effort. Thus, I may choose to use a uniformly sided frame (which, as far as I can tell, is the most common solution to framing a model).

The simplest of approaches places frames of identical structure along the length of the keel. Contemporary practice for my ship would have main frames consisting of double frames with filler frames in between. To be sure the approach to lofting out the frames is unaffected by the disposition we finally employ. Thus, for the sake of simplicity I will sketch out a basic framing plan. I leave it to you to interpolate how to fine tune your own framing plan to meet your expectations.

### The Square Frames

The majority of frames will lie across the keel at a right angle. Drawing them is no harder than drawing a series of straight lines.

**On the profile** plan these square frames will be straight lines set a distance apart equal to the width (siding) of the frames.

Earlier we set down station lines on the profile plan. If you recall, I suggested we use about the same spacing as appeared on the paper plan. We did not use the traced station lines because they were not exactly evenly spaced. With CAD we were able to be more precise. On the plan I have before me, the positions of the main frames fall on the station lines, something that simplifies things a bit. This is not always the case and, up to now, we have been careful not to refer to the lines as frames but as station lines.

The siding (width) of each frame needs to be known. My little ship will have frames 12 inches wide, which means a double frame will be a total of 24 inches wide.

So, by way of example, I begin at the dead flat station line. Forward of this line we can set down a parallel line at a spacing of 12 inches. We also put a line aft of the station line at the same distance. At the next station line forward two parallel lines fore and aft spaced 12 inches are also set down. These new lines represent the faces of the frames we will eventually put into our ship.

No doubt you will notice a sizable space between these frame lines. On the full size ship there may be two single frames leaving a space between frames (at the floors) of only a few inches. For the sake of example, I am choosing to set one single frame between the main double frames. The math indicates a spacing of 9 inches between the

frames. This particular layout is immaterial to the basic principles of laying out the framing plan. You will, of course, decide upon the framing that reflects your ship in the light of the adjustments you incorporate for the sake of your model.

For our example, we can set a parallel line 9 inches from the frame lines we have just added. The result is a complete set of frames between two of our station lines. In point of fact, this is all we need do for the square frames. The exercise caused us to think through the spacing of our frames, but since they will be identically placed there is no need to draw in all the other square frames.

**The half breadth plan** receives the same treatment. A set of lines representing the faces of the frames is set down parallel to the respective station lines. Again, it is unnecessary to draw out all the frames. A sample of lines at the dead flat station suffices.

On our ship, the square frames terminate well before the bow and stern. On my little ship, the last square frame coincides with the fourth station line aft of the forward perpendicular. At the stern, the last square frame coincides with the sixth station line forward of the after perpendicular. The lines for each face of these terminal square frames can be drawn in with some profit. Simply follow the same procedure of setting down parallel lines at 12 inches from the station lines.

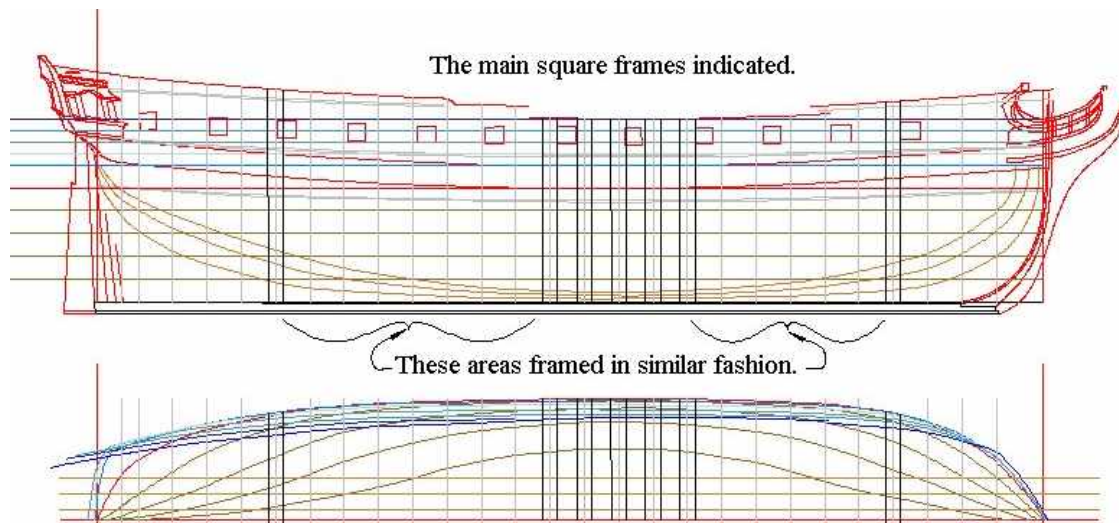

### **The Cant Frames**

Some building practices set the foremost frames at an angle to the keel. These cant frames decreased the amount of bevel required in order to receive the planking. There are a number of rules of thumb to be observed in designing cant frames, but our task is to mimic the existing plan. Because I have the original framing plan I can set my cant frames by taking their position from the paper plan. This is the first time we must take a measurement directly from the paper plan, it may not be the last. The method is simple enough, however.

**On the half breadth plan** the cant frames appear as straight lines. For this reason we want to draw them in here first of all. A couple of observations may be helpful

as we proceed. The cant frames are set at varying angles with the inclination increasing as we move forward. No frame is set at an angle greater than 45 degrees. So, if you must reproduce a framing plan without the original plan, add only so many frames as will meet this rule. Also, the heel of the frames are spaced closer to one another than the square frames. Perhaps the best way to get a feel for how the cant frames are spaced at the keel is to examine a number of models so constructed. Even better would be to obtain a framing plan for your vessel of one of the same class and construction.

I have such a plan and will take measurements to be transferred into my CAD program. One way to take measurements is to use dividers, determine the distance

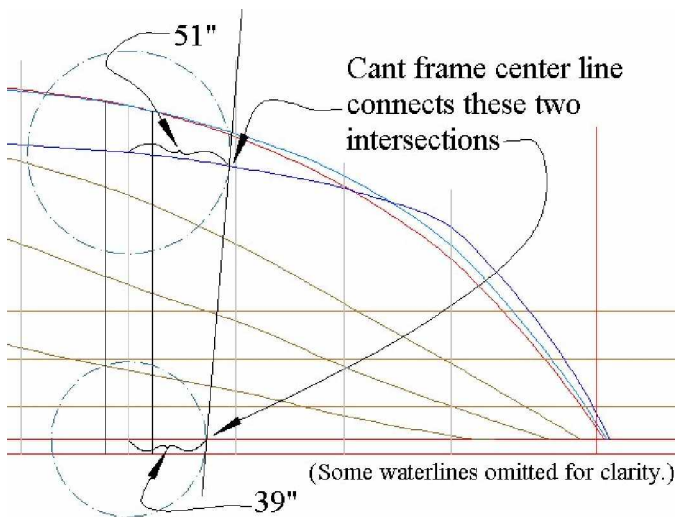

between the points and multiply by the scale of the drawing. Or the dividers can be compared to the scale ruler on the drawing itself (often but not always present). In lieu of dividers you can use a strip of paper aligned between the two points to be measured. Two pencil marks set onto this tick strip can then be measured and scaled or compared to the scale ruler.

In this way I have determined that the first cant frame begins 3 feet 3 inches forward of the square frame at the bow. On the

half breadth plan I draw a circle with a radius of 39 inches and its center point at the intersection of the square frame's station line and the side of the keel. Where this circle intersects the side keel line forward is the beginning point of the new cant frame.

From the original paper plan I determine that the top of the cant frame intersects the cap rail 4 feet 3 inches forward of the square frame. Again, I draw a circle with a 51-inch radius and centered on the intersection of the square frame's station line and the cap rail. The intersection of this circle with the cap rail forward gives me the second defining point for the new cant frame. A straight line connecting the beginning and ending points sets out the cant frame's center line.

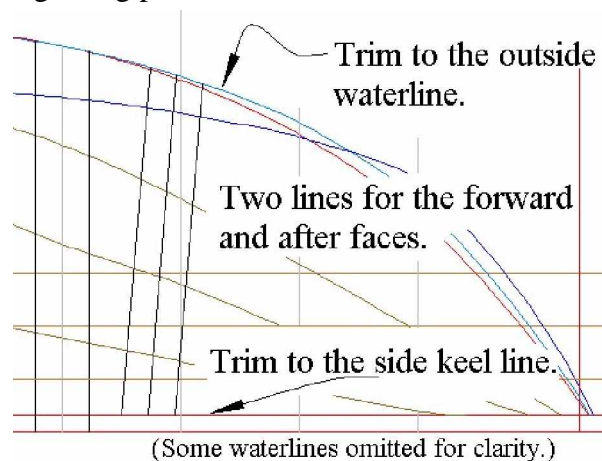

At this point I am drawing a double frame so the next step will be to line out the forward and after faces of the frame. This is achieved in the same manner as the square frames using the newly drawn cant center line as the line of reference. After setting down two parallel lines (depicting the faces of the cant frame) 12 inches from the center line, there will be a need to adjust the lengths of the face lines so that they begin at the

side keel line and end at the furthest waterline outboard. All construction circles can now be erased. Your first cant frame has been drawn in.

The other cant frames are drawn in the same manner. Determine the position for the heel and head of the frame, draw a line representing the center of the frame and place two parallel lines on either side for the forward and after face.

At the stern the process is no different. The only novelty comes with the final cant frame that will receive the transom timbers. This frame, called the fashion piece, will vary somewhat according to your vessel. The principle is nonetheless the same for all the cant frames.

I should remind you that I have spoken only of the main frames (both square and cant). Historically, the area between these frames would have been filled with two (or three) single frames called filler frames. How you want your model to appear will dictate how you treat this open space. However you choose to frame your ship, the principle for setting down the filler frames is no different.

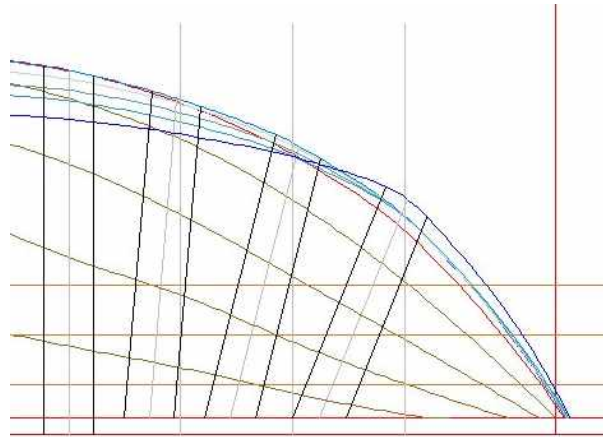

The forward cant frames drawn in.

**While on the profile plan** straight lines represented the square frames, the cant frames will have a curved appearance. In essence, we are looking at the square frames

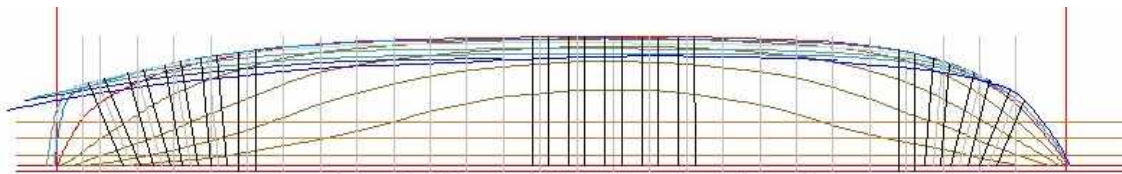

The main fore and aft cant frames drawn in

edge on, but the cant frames have been rotated slightly to our line of sight. Hence, the cant frames must be projected from the half breadth plan to the profile plan in a process very familiar to us now. As we have before, we will use a combination of construction lines, polylines and splines to depict the cant frames. We will place vertical construction lines onto the half breadth plan in order to establish intersection points on the profile plan. These will define the appearance of the cant frames.

Before we can start, however, there is another bit of information we need to add to our drawing. The square frames all rest (more or less) on the keel line. The cant frames are set into the deadwood at the stern and the rising wood at the bow. The heels of the cant frames are elevated above the keel line and it is this line (the bearding line) that must be added to our drawing. It may be present on the original paper plan in which case we simply measure the height of each frame above the keel line and transfer that distance to the CAD drawing. Absent the line on your paper plan, you will have to reconstruct the line. This, I should think, is a task for naval architecture and thus lies outside the confines of this treatise.



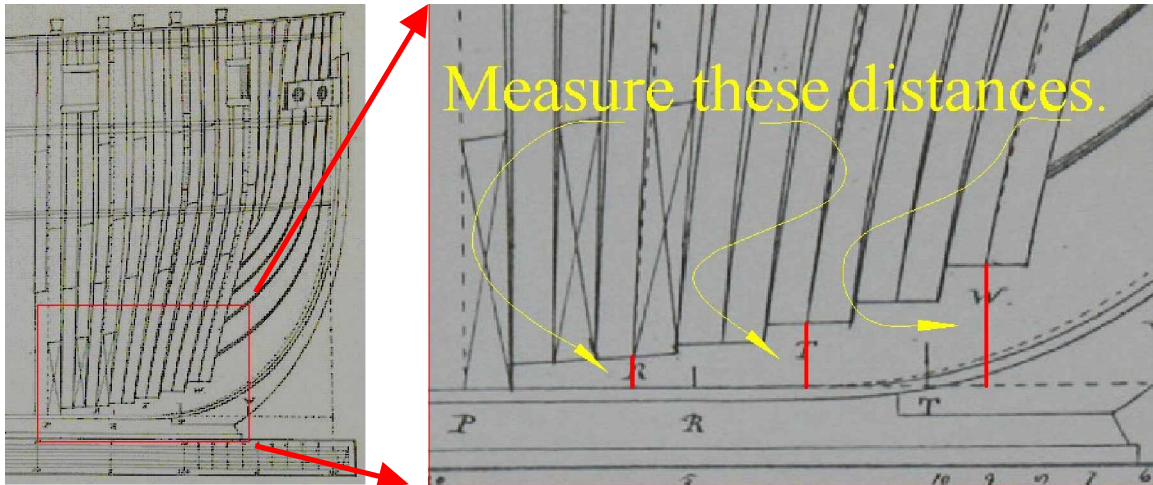

But let us think of happier things and that we have the information provided for us.

For each cant frame, we need to know the distance from the keel line to the heel of the frame. This is measured off easily enough with dividers or a tick strip and converted to real world dimensions. For example, on my ship I have three main cant frames at the bow. They are (from aft to forward) set at distances above the keel of 6, 14 and 27 inches respectively. With this information I am prepared to project the cant frames at the bow onto the profile plan.

Let us draw one face of the cant frame furthest forward. I select this frame because it will have the most pronounced curvature on the profile plan and, for that reason, will be the easiest to draw. To that end, let us also begin with the forward face of this frame.

The frame begins at a height of 27 inches (you will recall) above the keel line. On the half breadth plan I set a vertical construction line at the intersection of the forward face and the keel line. Where this construction line intersects the keel on the profile plan I place the center of a circle with a radius of 27 inches. At the intersection of the circumference of the circle with the construction line I have the point at which the frame begins.

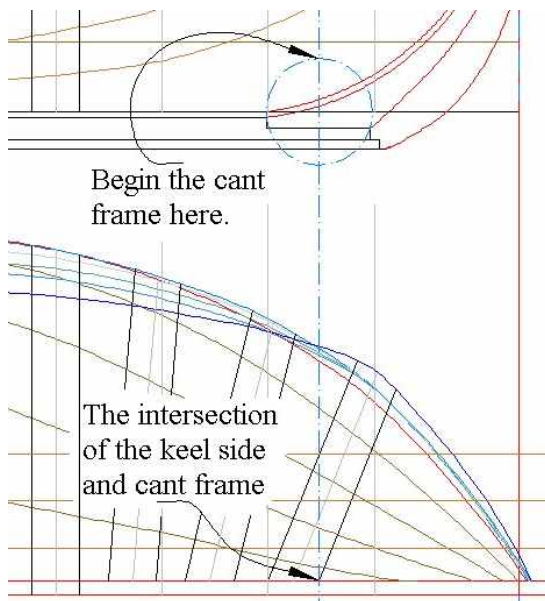

Vertical construction lines are then placed on the intersections of the waterlines and the frame line. As with the station lines, we will be greatly confused by placing down all the construction lines at once. So we prefer to place just a few construction lines at a time, mark the appropriate intersections with a polyline, erase the construction lines and repeat the process until every waterline/frame line on the half breadth plan

has an intersection mark on the profile plan.

Start with the water lines below the wales. Once you have set these in place and marked the profile plan with a polyline you can erase all the construction lines.

Now things might get interesting. You have, no doubt, noticed that the upper waterlines run quite close to one another at certain places. This is why we suggested that different colors be used so we could differentiate among them more easily. Even at that, we will have difficulty in telling which construction line pairs with which waterline. When that happens, just slow the process down. On occasion I have worked with just

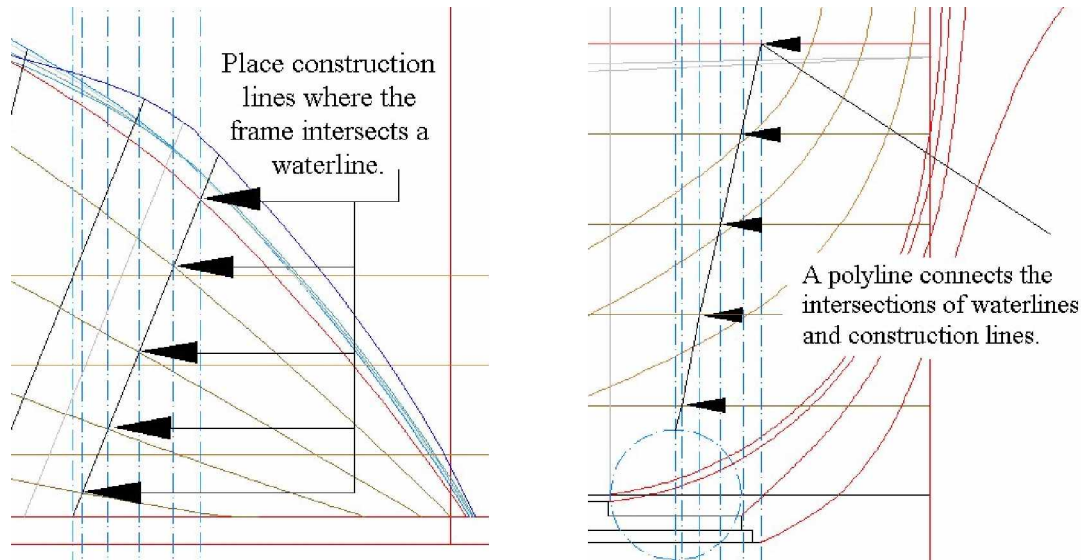

one construction line at a time. In that case I marked the intersection point with a straight line that began at the intersection and then tailed off to the side. This method makes finding the intersection point easier (a line is easier to see than a dot) and makes erasing the marker line easier as well.

At this point, then, we have a polyline indicating the cant frame below the wales and either a polyline or a series of marker lines indicating the shape above the wales. You will remember to treat the cap rail line as you would a waterline. This being the case, we are ready to join the points with a spline.

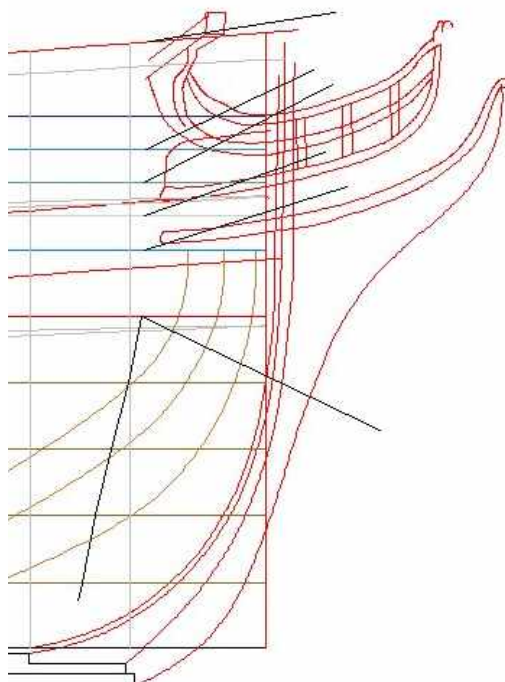

Throughout our project, we have benefited from the ability of CAD to zoom in on our drawing. When the need has arisen we have been able to distinguish between lines that were close. Perhaps it took a session or two before you mastered the art of zooming in and out, but I think I can by now assume you are able to pick out an intersection point even when it falls almost impossibly close to another intersection. That is one of the great utilities of CAD, we can achieve a degree of accuracy that was once reserved only for the eagle eyed draftsman.

With that excursus to one side, we return to our cant frame on the profile plan. As

you have guessed, it is a simple matter now to join the intersection points on the polyline and the marker lines. (The beginning point lies on the end point of the polyline; CAD will allow you to snap to this vertex.) These fall on the waterlines and, now that they are joined with a spline, make up the graceful curve of the cant frame.

The after face of the frame is projected onto the profile plan in exactly the same fashion. The other cant frames require no different treatment. When done you will have a set of cant frames at the bow.

Cant frame at the stern introduce no new wrinkle in our drawing. Again, we must take the bearding line from our paper plan and project the level of the heel of each frame with a construction line and circle. Each cant frame is then drawn in.

As with the square frames, there were filler frames between the main cant frames.

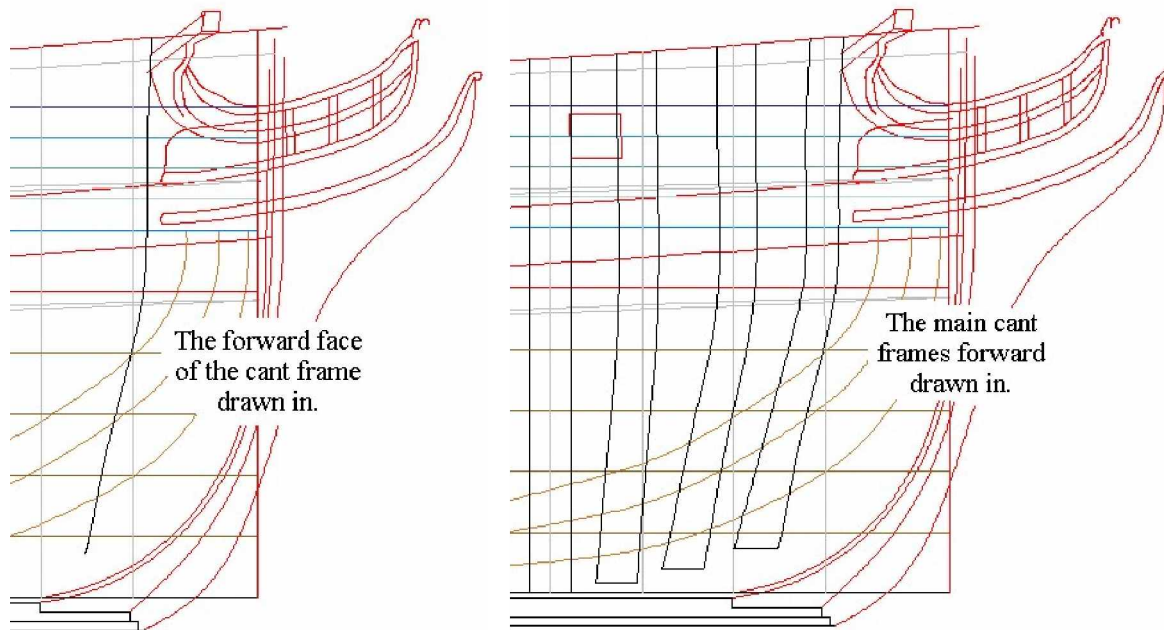

Their disposition and projection employ exactly the same procedure we have just outlined.

**In fact, we have not drawn the cant frames** as they will be cut out and put into the ship. The projection onto the profile plan gives us a perspective view. This process of drawing them out helps us visualize possible problems later on. We can, and should, examine the lines of the cant frames for fairness. Any untoward dips and swells should be addressed by re-fairing the attendant waterline. I found a few places that were off by a half inch (real world dimension) and have pondered the virtue of making such a slight alteration given that my model will make the variance something on the order of .005 of an inch. I may trust a piece of sandpaper to make that small a correction.

## Of Guns and Things

Other elements of the framing plan include the gun ports, sweep ports (if any), and the level of the futtock heads. These are simple matters to include if we have sufficient information on the actual vessel.

**I have decided to place the gun ports** between main frames in a manner closely aligned with the original plan. The precise placement may be shifted a few inches (real world) since I have already decided to simplify the frame construction somewhat.

The gun ports should have been traced in earlier. Of course, the tracings do not line up with the frames we have indicated. The traced ports will, however, give us enough information to redraw our own gun ports.

Even though the ports themselves are rectangular, they fall on a curved sweep from stem to stern. This sweep can be indicated temporarily on our plan by connecting the traced ports with a spline. By doing so I will be able to place a gun port where the spline intersects a frame. Starting at the stern, say, I begin the spline at the after upper corner of the traced gun port. In order to create a smooth curve, I set the spline down at the after corners of every other gun port (or every third depending on my mood). The spline terminates at the forward upper corner of the last gun port. As you inspect your line you will probably notice how close all the traced gun ports are to this spline. After repeating the process for the lower corners of the traced gun ports I have a good definition of where the ports will be. The traced ports should be erased as they have served their purpose.

Now, at each position where a gun ports needs to be drawn in I can draw in a gun port using the splines as guides. As with so many things, there were rules and formula to

- One way to indicate gun ports.

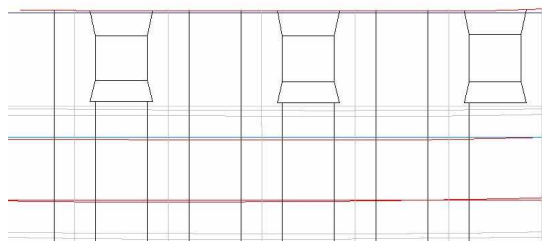

determine the dimensions of these ports. If we are sticklers for accuracy we must know these rules and line out the gun ports accordingly. Fortunately on my little ship the gun port dimensions line up well with the frames I have already drawn in. This comes as no surprise since in placing my frames I had mimicked the original plan fairly closely.

So, the task at hand is a matter of drawing a horizontal line from the upper left intersection of the spline to the opposite frame. A similar line is drawn for the bottom of the frame and the port is done. This is repeated for each gun port. It remains to decide what size timber will be used for the gun port (the sill and lintel) and how they will be set into the frame. On the drawing, place a line parallel to the upper and lower gun port lines at a distance of your chosen dimension. Letting the piece into the frame is a matter of extending the piece, drawing the ends, and trimming the frame accordingly. (Erase the two splines.) I should think other apertures such as for sweep ports and ballast port present no problem.

**The heights of the floors and futtocks** should also be included. This information is on my paper framing plan and it is short work to transfer it to the CAD

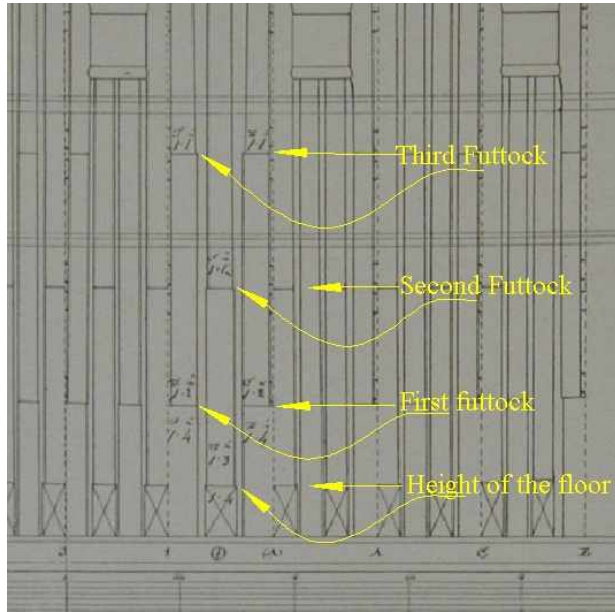

drawing. How you obtain this information will be determined by the project before you. Many models are made with no real attention given to the real world placement of futtock heads. What is most needed is a set of lines that show where you have decided to put your futtocks, whether it is in mimic of the real world ship or a layout based on your best estimations.

Once again I can use dividers or a paper tick strip to take measurements from the original plan. The distance from the keel line to the top of the floor is measured out and recorded. This should be done at the dead flat frame, at one or two frames between the dead flat and the cant

frames, and finally on the last frame with an indication of the floor timber height. At this point we have drawn in a line showing where the head of the floor terminates.

The same procedure is followed for the first futtock head. Again, only a few points along the length of the hull are needed since we are looking for a smooth curve. The line will begin and end with the frames at the extreme ends of the ship. As you suspect by now, the same process gives us lines for the second, third, and the other members of the frame.

The height of the floor at the mid point (above the keel) is equal to the distance between the keel and the keelson. So, in effect, we need to have the keelson line added to the framing plan. This can be drawn in exactly the same manner as when we were laying out the keel plan earlier.

We will use these lines when we finally loft out the frames. Obviously, if we are going to create a pattern for each member of a frame we have to know where each futtock begins and ends. We could just choose an arbitrary juncture of pieces, but that would prove somewhat unsatisfying. On the other hand, this presupposes you are planning to build up your frames one futtock at a time. If you choose a different method (such as making frame blanks and cutting out the frame all in one cut), then these futtock lines are not as important. And a model built as a plank-on-bulkhead structure will need even fewer of these reference lines. Let your choice of building method determine how much information you need on your drawing.

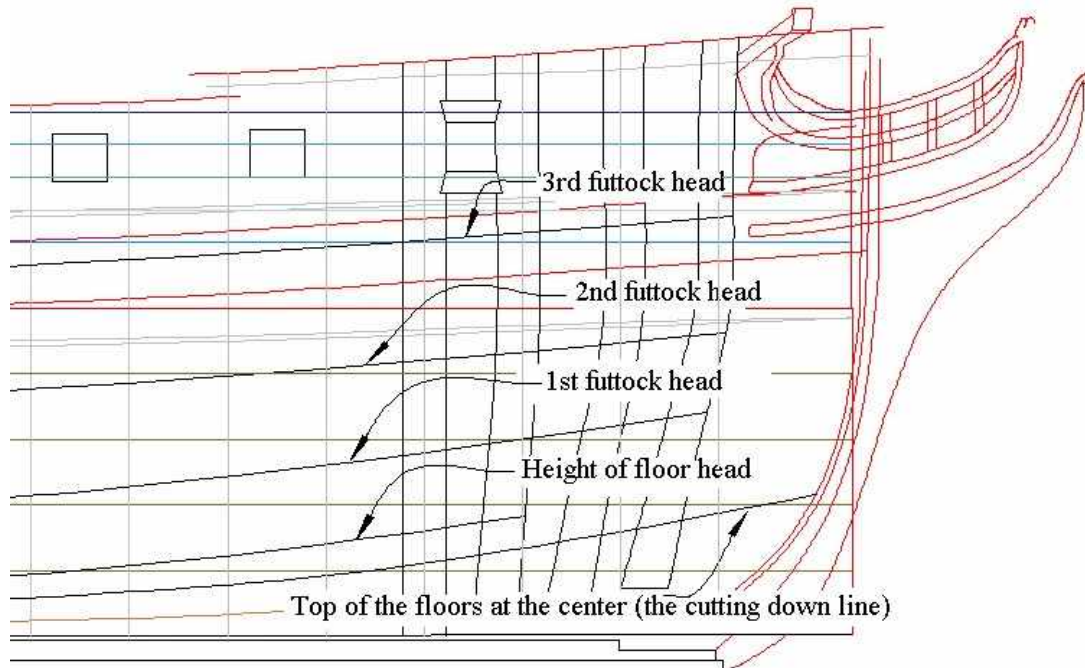

**Hawse pieces** fill in the last open space at the bow. They are timbers running parallel to the keel, but they tie into the last cant frame. Drawing them out is as simple as drawing and projecting the other frames.

For my project, I have decided to place four hawse pieces, 12 inches wide and spaced 9 inches apart. The knowledgeable reader will discern that this is not precisely the correct manner of disposition. For my model, however, this layout will prove both instructive and simpler to construct. As has been said so often, your disposition depends on a variety of factors.

The hawse pieces are first drawn in on the half breadth plan. Nine inches from the side of the keel (at the bow) we can set down a line parallel to the side of the keel.

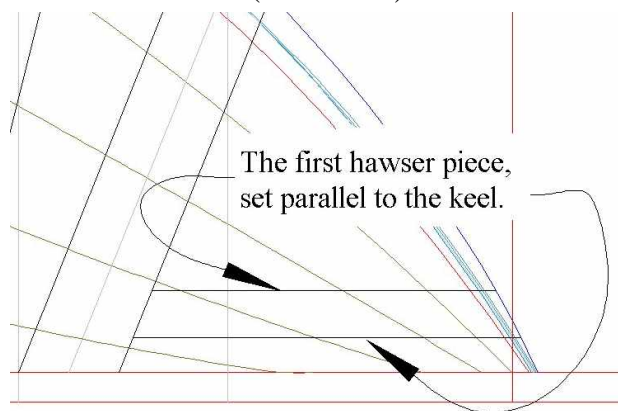

This is followed by another parallel line 12 inches distance. The line is made to begin where it intersects the forward cant frame and to end at the intersection with the outermost waterline. There, we have the first hawse piece drawn in.

The other hawse pieces are drawn in the same manner. In actual ship building practice there may have been additional filler pieces, but for now I think we can be satisfied with

just our hawse pieces. Also, around the area where the hawse pipes penetrate the hull the pieces would be wider to the point of butting up against one another. For now, let us plan to put spacers in the gaps between hawse pieces to make the solid surface for the hawse

pipes. This, to be sure, is a compromise, but in doing so we will simplify our task somewhat.

It remains for us to project the hawse pieces onto the profile plan. The procedure we will use is so familiar by now that I hesitate, almost, to describe it again. It is just a matter of setting down construction lines on the half breadth plan and connecting the appropriate intersection points on the profile plan.

In point of fact, projecting the hawse pieces to the profile plan is the exact same thing as projecting the buttock lines. Both the buttock lines and the hawse pieces run parallel to the keel, and thus we would expect them to be defined in like fashion. The

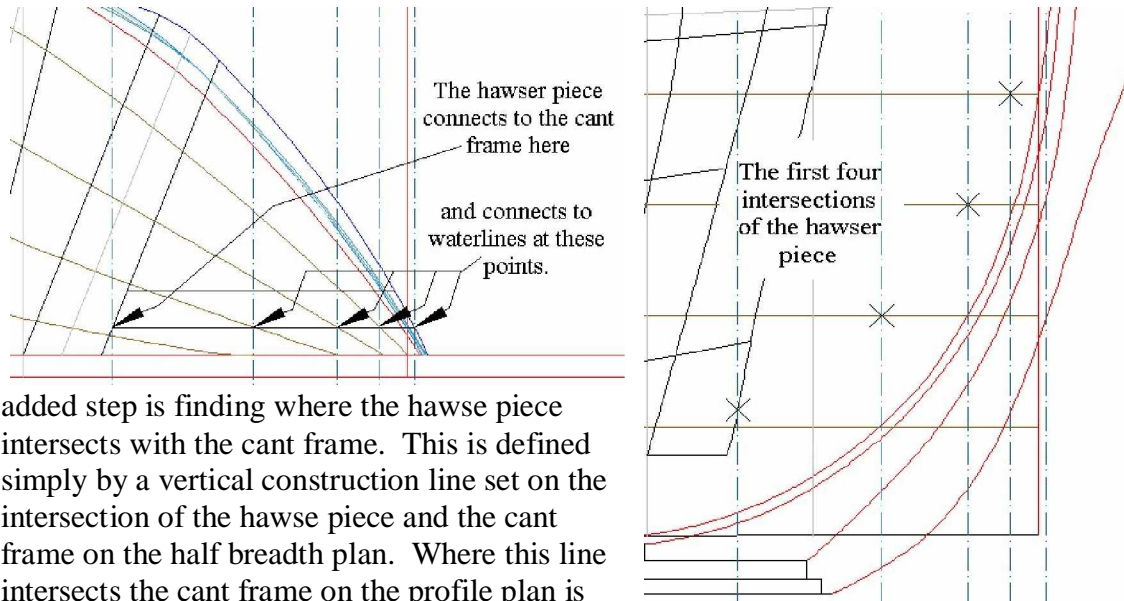

added step is finding where the hawse piece intersects with the cant frame. This is defined simply by a vertical construction line set on the intersection of the hawse piece and the cant frame on the half breadth plan. Where this line intersects the cant frame on the profile plan is the beginning point for the hawse piece. We stopped our buttock lines at the wales, but for the hawse pieces we just carry the process up to the cap rail.

If the number or proximity of construction lines becomes confusing, just break down the projection into smaller steps using polylines to mark of the points of intersection until you come back to join them with one spline. Because the hull may present an essentially vertical face at some point (depending on the shape of your particular vessel), you may even need to mark intersection points one at a time. This cannot be any worse a task than what you would have done on a pen and ink drawing.

For each hawse piece there will be two lines on the profile plan indicating the inner and outer face of the piece. Once they are all drawn in you have a nice depiction of the bow before you.

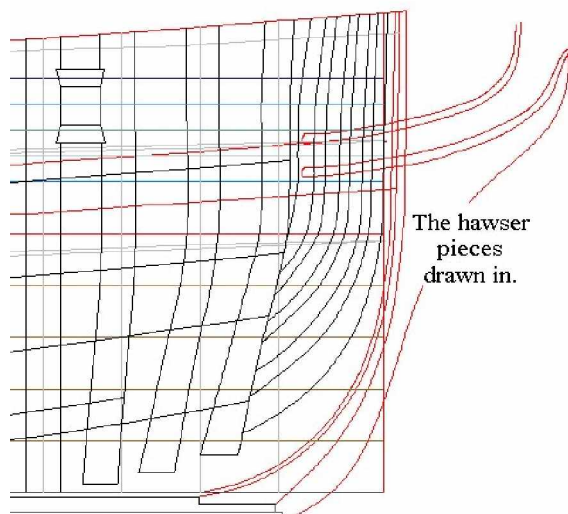

**The final framing plan** has a bewildering array of lines. To avoid hopeless confusion, I might suggest using different colors for the lines. We already know that a horizontal line will be a waterline; a vertical line will be a frame/station line. The curved lines will

include the buttock lines, the futtock lines, and at the bow the hawse pieces. Choose a separate color for each one of these and you will be able to pick out the line you want more easily.

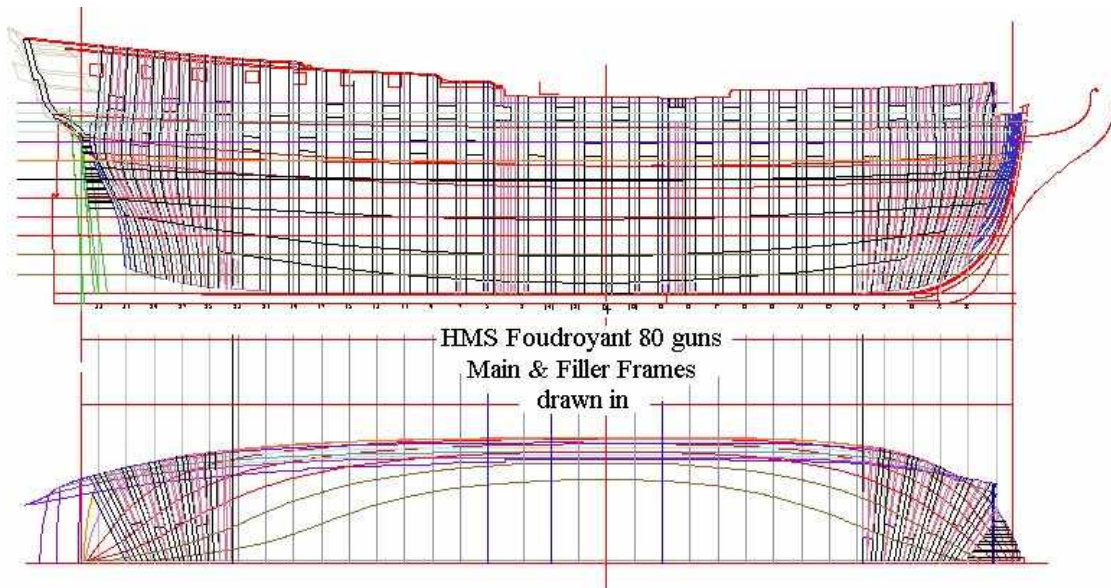



## Lofting Frames

All our work to this point has been but a preparation for this moment. We are about to loft out the frames complete with bevels, floors, futtock pieces and timbers. For each piece in the frame we will create a pattern that can be used for cutting out the real world framing on our model. Keep in mind that we are still using real world measurements in our drawing. We will be able to scale the end product to any scale we desire when we finish the lofting process.

### The Square Frames

The dead flat frame is the easiest frame to loft and so we begin there. This frame lacks any bevel to it and so we can put that question off for the moment. You already know how to loft out the frame, really, since you acquired that skill when drawing the body station lines. The procedure is exactly the same for the outside of the frame. The inner part of the frame presents a different problem, but easily addressed.

**A few preliminary adjustments** to the framing plan are necessary. I would create a separate copy of the framing plan so as to have working plan where lines can be erased and manipulated without losing work previously done. On this new framing plan, the first order of business is to set a half breadth plan beneath the body plan with the keel running vertically. The centerline of both plans must coincide. This is familiar to us from our prior work. The important thing here is that the half breadth plan has the frames indicated on it.

These frame lines will be used to project the shape of the forward and after faces of the frame onto the body plan. The frames lines can be mirror copied about the keel centerline, but for my approach I want a set of the frame lines on the right side of the vertical half breadth plan. The drawing will also be clearer if you remove the buttock lines from the half breadth plan.

Moreover, all the station lines must be removed from the body plan. Don't panic, these lines represent the station lines, not the surfaces of the frames themselves. They were useful in faring the plan,

but they are not needed for lofting the actual frames. You will be left with a body plan that has the waterlines extended from the profile plan, the center keel line and the side keel lines.

Finally, you will find it helpful to group the entire working drawing into one entity. CAD permits us to gather a collection of lines and treat them as one. In doing so, we can select the entire entity with a single click of the mouse. Here is why this is useful. When we loft out a frame, we will do so in the area on the body plan just now vacated. After the frame is lofted, we want to move it off the body plan so we can break it up into its constituent parts. This could be done with layers, but I find it easy enough to select the body plan with the lofted frame and then de-select the body plan. This leaves only the lofted frame selected, which can then be moved as I desire. There will be more on this later on.

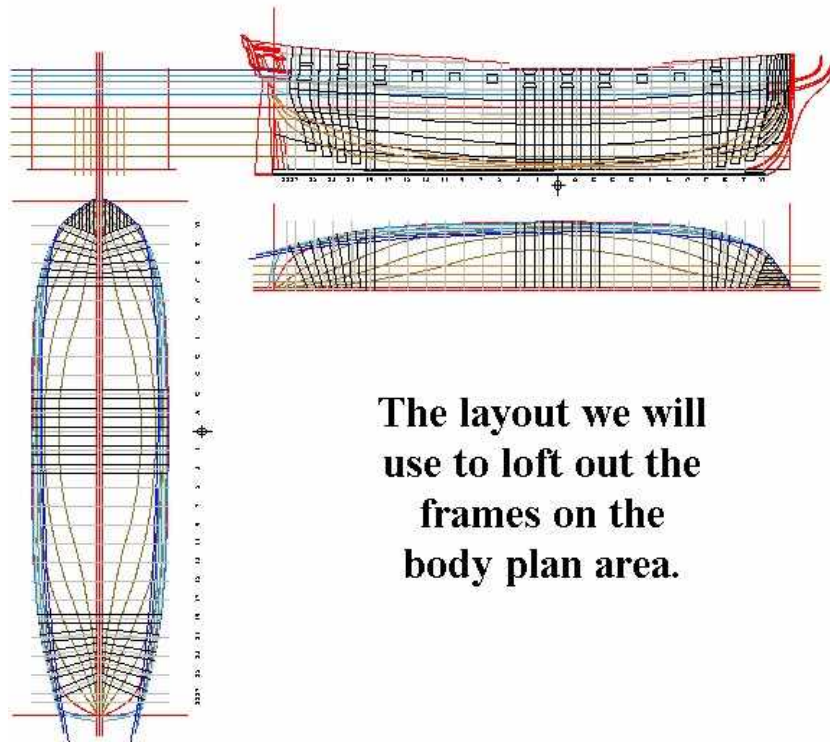

**The layout we will use to loft out the frames on the body plan area.**

I should think it evident that, with this arrangement of the plan, the profile plan can project information from the buttock lines onto the body plan with horizontal construction lines while the half breadth plan can project information from the waterlines to the body plan with vertical construction lines.

In selecting the dead flat frame, the issue of beveling is bypassed. Thus, to represent the frame we need only to draw out the outside and inside shape of the frame. When we drew out station lines on the body plan, we projected the shape from the profile and half breadth plans using construction lines. To draw the outside of the frame, we return to the procedure.

**To avoid confusion** I find it helpful to set the frame I am working on off from the other frames through the use of colors. The frames at present may be drawn in black, so I change the color of the forward face to blue and the after face to red. I do this on both the profile and half breadth plans. These colors are, of course, arbitrary. But using different colors makes line identification so much easier when zooming in on a part of the drawing. One of the great aspects of CAD is the ability to look at a part of a drawing close up, but the down side of zooming in is that one line can start to look pretty much like another. The use of colors to differentiate lines overcomes this pitfall.

Throughout the lofting process, I would recommend changing the forward face of the frame (in my case blue) to the same color every time. The same holds for the after face. Once the frame is lofted the lines should be returned to the original color (on my drawing, a black line for both faces). In this way I can always tell which frame I am working on and which face of the frame is being drawn at the moment. Also, the two colors for the forward and after faces will tell us how the frame is beveled when that becomes necessary.

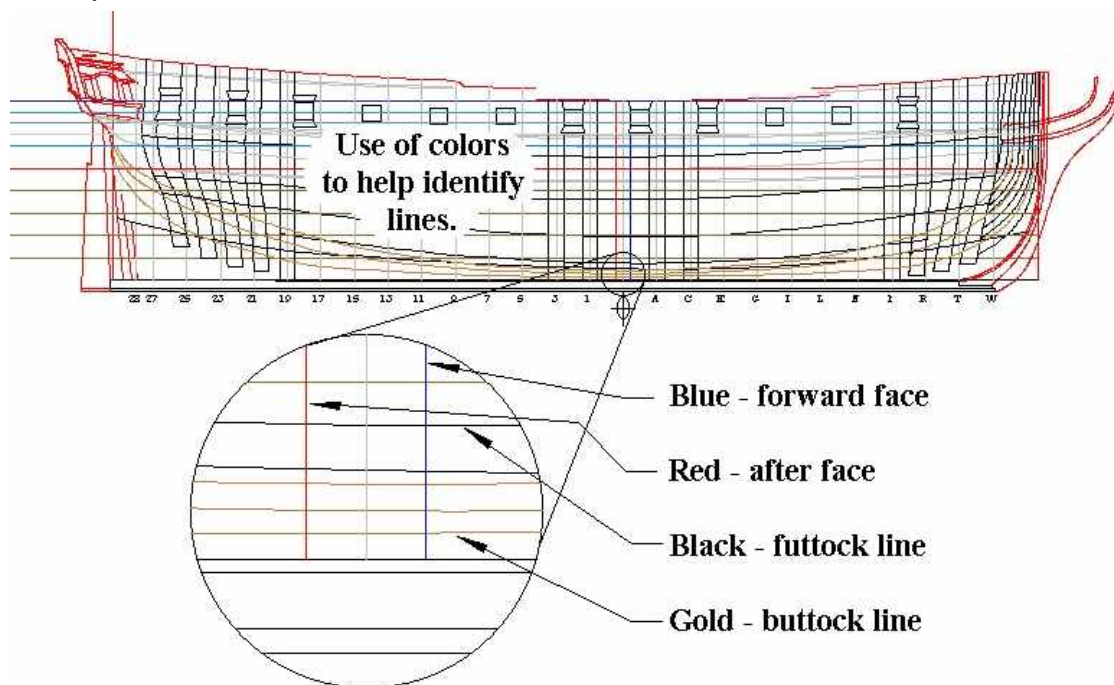

**The forward face** of the dead flat frame works just as well to define the outside shape of the frame. (At the dead flat, the after face will be virtually identical.) Knowing that the forward face is a blue line, I will have no trouble finding where it intersects with the various components of the frame. The frame will begin at the intersection of the side of the keel and the keel line on the body plan. This will be the case for all the square frames.

**Below the first waterline the buttock lines** define the shape of the frame. On the profile plan I place a horizontal construction line wherever the forward face (blue line) intersects a buttock line. On the body plan to the left each construction line will intersect the buttock line that defined it originally. For example, the first buttock line's construction line (on the profile plan) will intersect the first buttock line (the innermost buttock line) on the body plan. The frame line must pass through that intersection. This

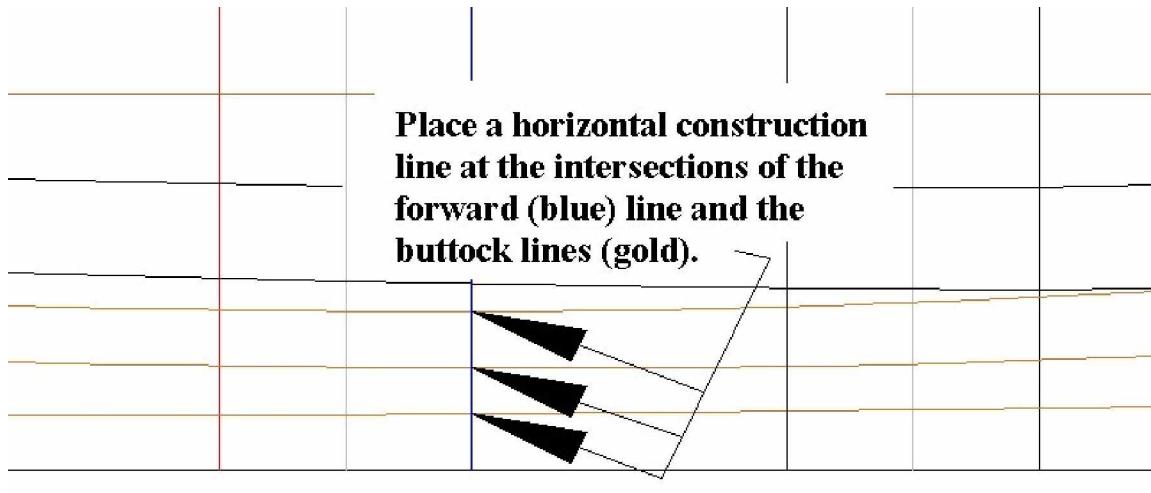

holds for all the other construction lines and buttock lines as well. This is nothing new, for we encountered this process some time ago when drawing station lines on the body plan. On my plan I have three buttock lines and, therefore, three intersection points on the body plan which are now connected with a polyline. As always, a tail is left to one side for ease in selection for erasure later on. The construction lines are no longer needed and can be erased.

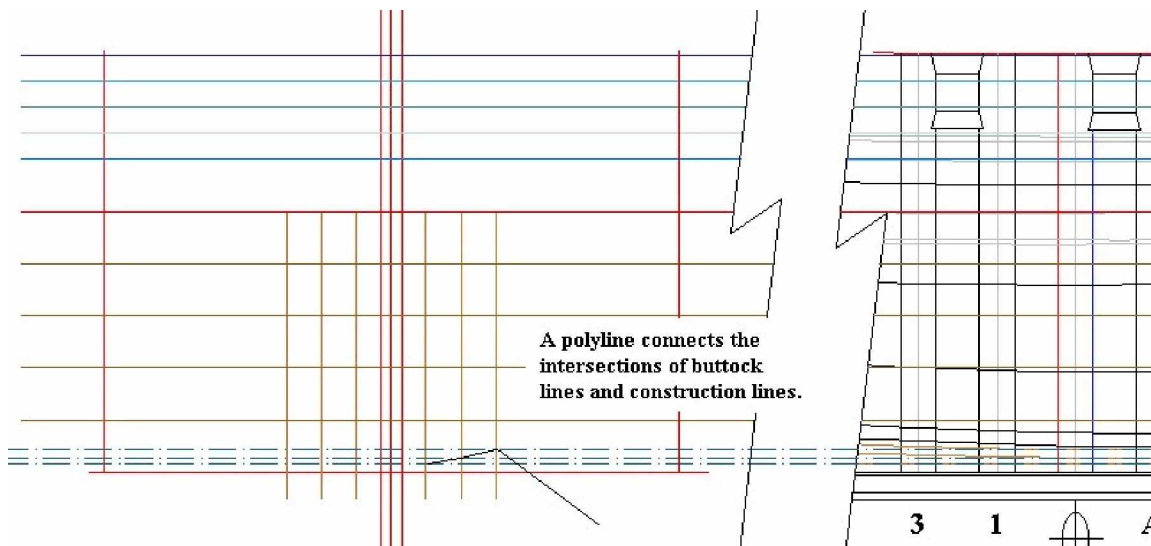

**The lower waterlines** come next. Again, we are breaking down the plotting of the curve into several segments to avoid a massive confusion of lines and intersections. Basically, we are tracing the frame first away from the centerline (which happens mostly below the wales) and then back toward the center (which is essentially above the wales). It is not the wales that defines the separation of steps so much as it is the broadest waterline from the center of the keel.

On the half breadth plan beneath the body plan we place a set of vertical construction lines at those places where the forward face of the frame (the blue line on my drawing) intersects a waterline. You will remember that we have given the waterlines various colors to help us identify them when zooming in on a given spot on the drawing. Surely you have noticed how simple it is to keep track of the lines on the basis of this color identification.

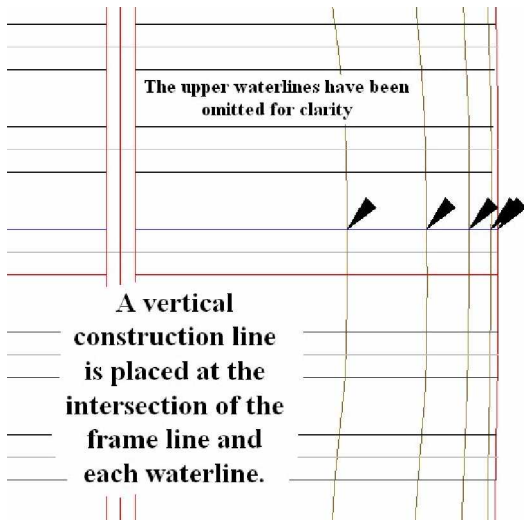

So, for each waterline below the wales I have a vertical construction line. These construction lines extend upward over the body plan and give me a set of intersection points that define the shape of the frame. Each waterline generates its own construction line, and that construction line defines an intersection where it crosses the corresponding waterline on the body plan. Now each one of the intersections is marked with a polyline (don't forget the tail).

Of course the waterlines above the wales receive the same treatment. Once again we mark the intersections of the frame line and the waterlines with vertical construction lines. On the body plan the appropriate intersections are marked with a polyline. Then the construction lines are erased.

The final point needing definition is the junction of the frame with the cap rail. We know to

place a horizontal construction line on the profile plan at the intersection of the frame line and the cap rail. On the half breadth plan we place a vertical construction line at the same intersection of the frame line and the cap rail line. Where these two construction lines intersect on the body plan we have the terminal point of the frame.

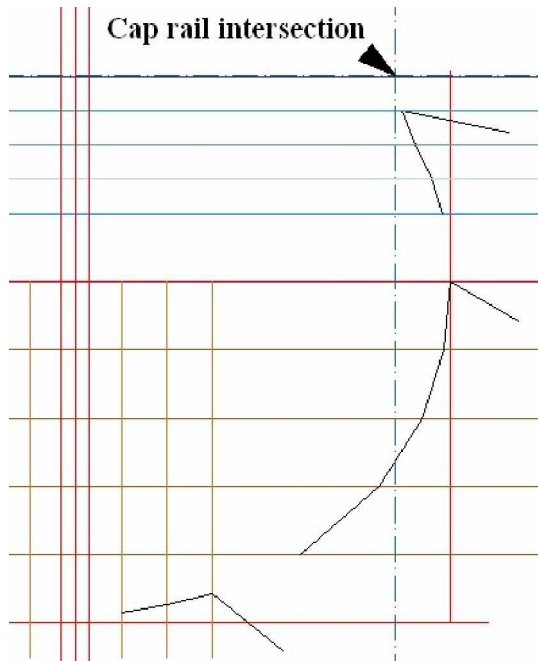
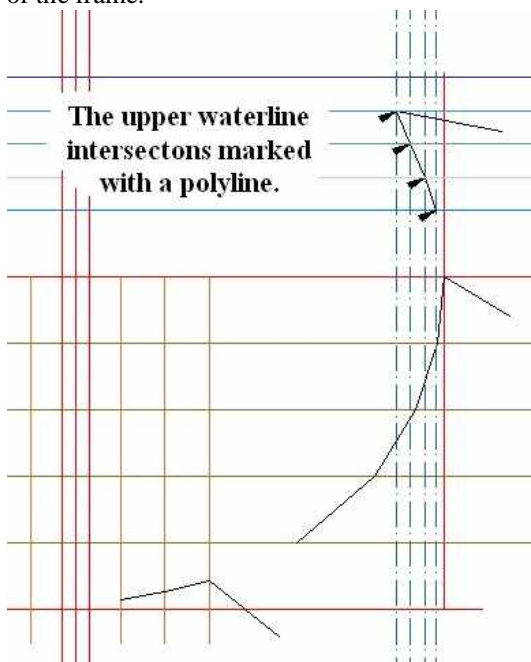

Now all the points defining the frame are in place. It remains only to join all the lines with a spline. I might suggest using a blue spline since that is the color I have chosen for the forward face of the frame. Begin at the juncture of the keel line and the side keel line. The spline is continued upward at each intersection marked by the three polylines. The spline terminates at the intersection defined by the cap rail. This finishes off the outside curve of the forward face of the dead flat frame.

**The after face** of the frame could be drawn at this point by following the same steps along the after face line (the red line in my case). Elsewhere along the hull this would be advantageous, but at the dead flat the forward and after faces are virtually identical and so no good purpose would be served. Instead, we are content to proceed with drawing the inside of the frame.

**Nothing** on the lines we have drawn thus far indicates the inside line of any of the frames. This is not to say we do not have sufficient knowledge to draw the line. It is only that the information is not on our plans. We must obtain the necessary data from research.

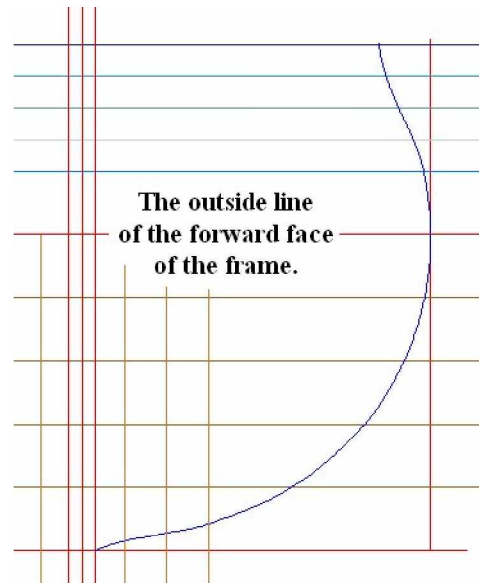
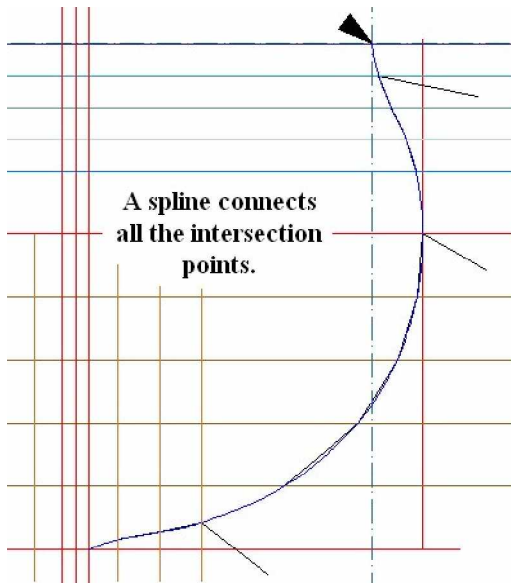

Historical data will tell us the dimensions of the frame. For my little ship I learn that the floors were 10 inches thick at the head. The first futtock should be 9 ½ inches at the head, the second futtock 9 inches, the third 8 inches, and the fourth 7 inches. The original framing plan for my ship shows only four futtocks, so the fourth futtock terminates at the cap rail. These measurements, for which you will trust me, will guide our construction of the inside of the frame.

**The height of the floor** above the keel is known from the cutting down line already placed on the framing plan. By now you know we will project this dimension from the profile plan to the body plan with a horizontal construction line. On the body plan the intersection of this construction line and the midline of the keel is the height of the floor. An easy way to mark this point is to draw in a line from this intersection to the intersection of the construction line and the sideline. After erasing the construction line the little line we have drawn in remains as the indicator of the floor's height. In case you were wondering, this line also marks the dimension of the heel (bottom) of the first futtock.

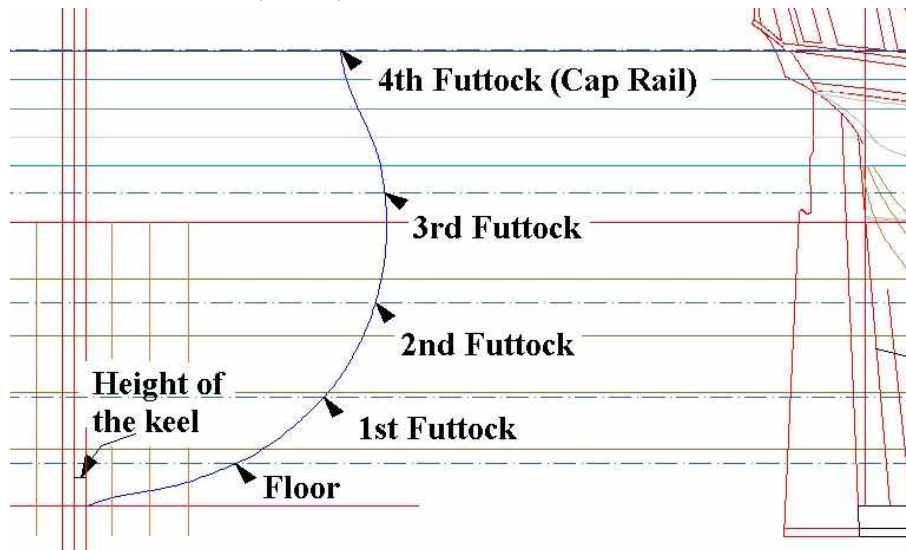

**The division into futtocks** occupies us next. The heads of the futtock pieces are indicated on the framing plan by the futtock lines we added. The ever-faithful horizontal construction line transfers this information from the profile plan to the body plan. Along the forward face of the frame (the blue line for my drawing) I want to place a horizontal construction line wherever the line intersects a futtock line.

Obviously, as we follow these construction lines to the left we find them crossing the frame line at the precise position where we want our futtocks to begin and end.

The ends of the futtocks lie on a perpendicular line drawn at the intersection of the futtock construction lines. Well, to be more precise, we draw a line perpendicular to the tangent line that intersects the construction and frame lines. Fortunately, CAD does this for us. Each program will have its own

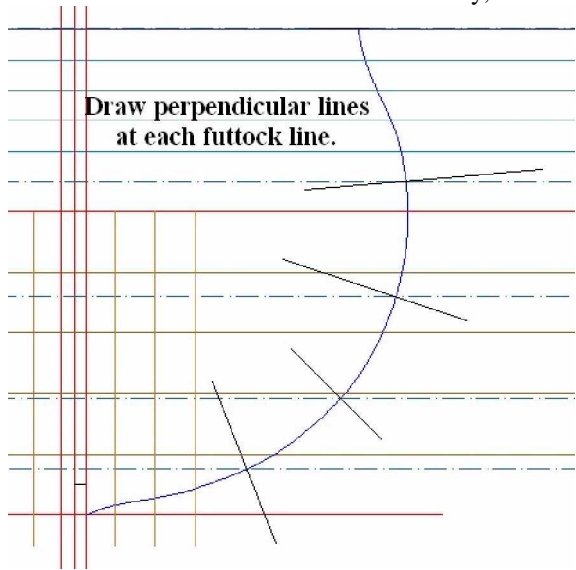

**Draw perpendicular lines at each futtock line.**

approach to accomplishing this task. On my inexpensive program, I chose to use a tool that is a perpendicular construction line. By clicking on the frame line close to the intersection of the futtock line, the computer accepted the frame line as its referent. Then, by clicking on the intersection point, the program sets down a construction line that is perpendicular to the curve of the frame line at that point. It was then a simple thing to draw a straight line along the construction line of sufficient length to extend well past the sides of the frame.

(Some readers will be astute enough to note the oversimplification of my description of a line “perpendicular” to a curve. Still, the mathematics of the matter need not bog us down.)

**The inner surface of the frame** now receives attention. We already know the distance between the outside and inside lines of the frame at the various futtock lines. So, in the first instance, we want to indicate a distance of 10 inches at the head of the floor. By placing the center of a circle with a radius of 10 inches at the intersection of the futtock end line and the frame line, the juncture of the circle and the end line is the point through which the inside frame line will pass. The identical process is followed at the other futtock lines, but with circles of the appropriate radii (9 ½, 9, 8, and 7 inches). We now have a number of points through which the inside line will pass. Unfortunately, these are not enough to give us the correct shape of the curve.

The top part of the frame exhibits an interesting curve caused by the “tumble home” of the hull. Because the curve changes its direction, we need more points to help the computer properly fill in the curve. For this reason, we will benefit from setting down another set of perpendicular lines and circles so as to generate additional points of intersection. One line and circle between each pair of futtock line will suffice save at the upper extremity of the frame. Between the cap rail and the next futtock line down, two or three such sets may be necessary in order to give adequate definition to the curve of the inside line. For the radius of the circles, you might use a figure half way between the radius of the circles already drawn on either side. This amounts to a word problem in mathematics but is easily enough figured out. On my ship the circle between the floor line and the first futtock would be 9 ¾ inches, for example. As soon as we supply the other lines and circles we will be ready to draw in the inside curve of the frame.

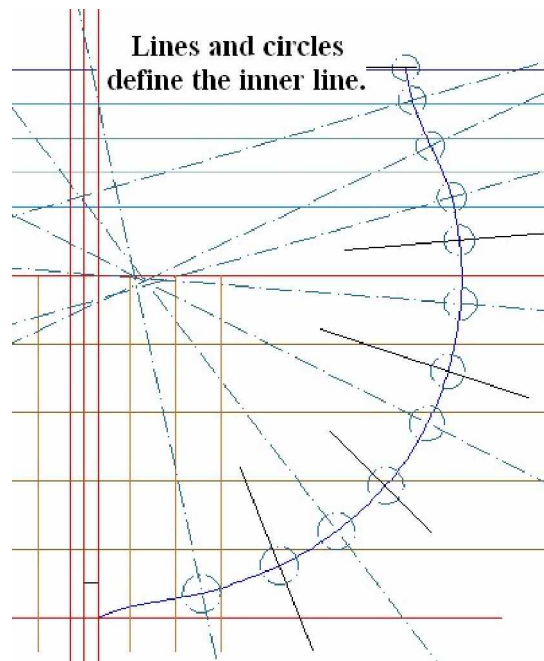

**Lines and circles define the inner line.**

The inside line begins where the top of the floor (that we drew in earlier) and the side of the keel intersect. From there the spline connects all the intersections of perpendicular lines and circles. It terminates at the cap rail. All the construction lines and circles are to be erased leaving only the inside and outside frame lines, the futtock lines and the top of the floor.

A frame attaches to the keel, but how it is attached depends on the ship, the country of origin, the era, etc. In other words, you will need to think through how you are joining your frames to the keel in order to represent the union on your CAD plan. For my ship, I will be cutting a notch in the frame to set down over the hog/deadwood piece on top of the keel.

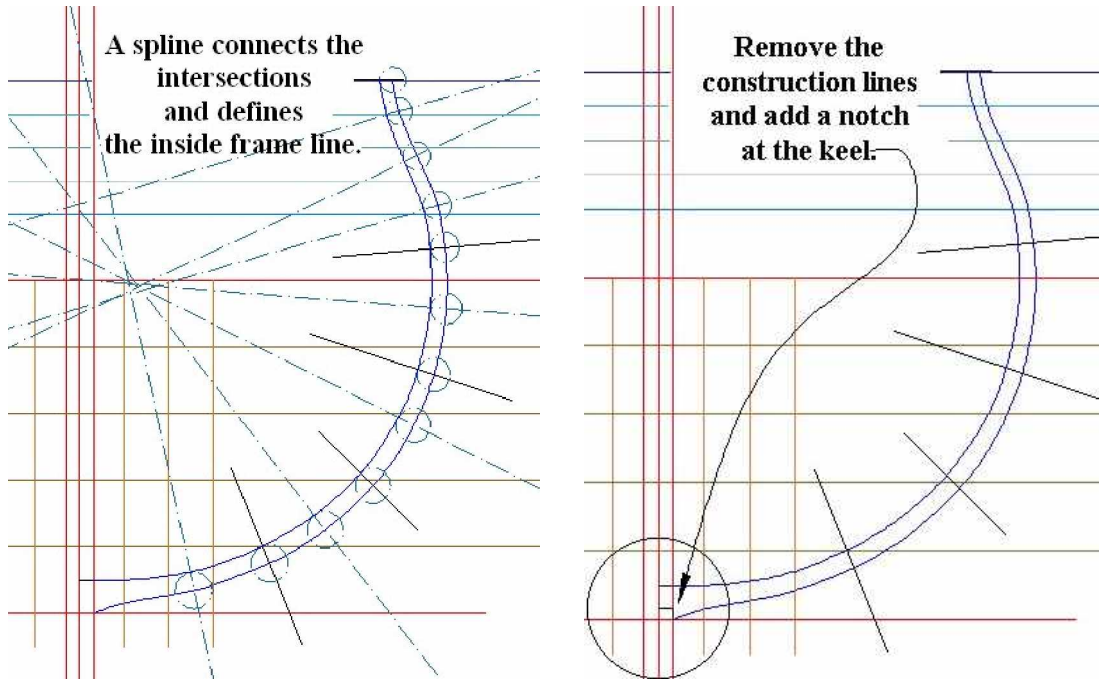

Drawing this notch is simple enough. However, we should draw only half of it. After all, we have only drawn half a frame to this point and it would make sense that we would draw only half a notch to go on it. Eventually, as you suspect, we will let CAD produce a perfect mirror copy of the frame half on the other side of the keel centerline. My notch is cut into the frame for six inches and has the width of the keel. There are a number of ways to lay this simple item out. It will consist of a straight line six inches above the keel that then follows the side keel line back down to the keel.

**Creating the pieces of the frame** will be simpler if we lift the frame off the body plan and set it down on a blank part of the drawing area. Select the frame lines, the futtock lines and the notch lines, then copy and paste them to a blank area. This leaves your work on the body plan for the moment in case you need it, but we will work with this new copy of the frame.

Actually, now is the best time to create the individual pieces of the frame. The basic approach will be to create a copy of the frame and then trim away everything that is not a part of the piece we are drawing.

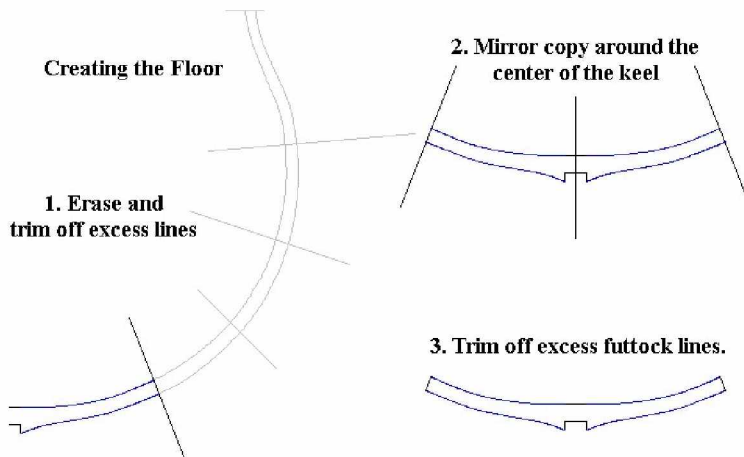

Place a copy of the frame in a separate area. Next, trim or erase everything that lies beyond the head of the floor. Then mirror copy the remaining line with the center of the keel as the axis. (Recall that the top of the floor and the notch both terminated at the centerline. Therefore, a vertical construction line set at the end of either of these lines will serve as an axis for the mirror copy. Of course,

erase the construction line when you have finished the copy.) Finally, trim the excess lines at the floor head to produce the final piece. Having produced the floor, label it with both its name and its location.

**The individual futtocks** are segmented out with a similar approach. Place a copy of the frame on an open work area. Then all lines not pertaining to the futtock in question are erased. The futtock lines are trimmed back to the width of the piece. It is labeled and we are done. The first futtock presents a small wrinkle in that it we must join the notch and the top line with a straight line. The other futtock pieces are just a question of trimming back to the appropriate futtock lines.

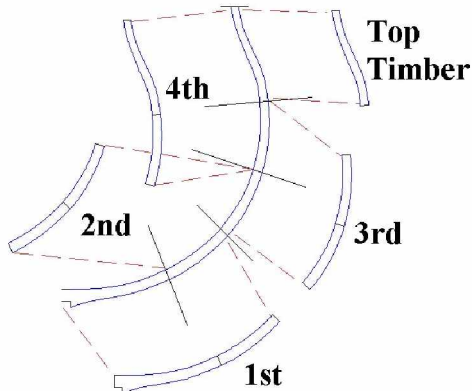

Keep in mind that each futtock will overlap the piece beside it. This means, for example, that the first futtock will begin at the centerline, extend past the floor head and end at the first futtock line. The second futtock begins at the floor head, extends past the first futtock line and ends at the second futtock line. If you will keep in your mind's eye an image of the pieces overlapping one another in a staggered fashion you will not lose your bearings as you extract the individual pieces from the frame. (Another way to think of this is that each futtock will embrace three futtock lines, one at each end and one in the middle. Obviously, this is not true for the very top piece and for the floor piece.)

Each futtock should be grouped into one entity by your CAD program. Grouping is such a useful tool that it merits a brief discourse. When you draw a line, a curve, a rectangle or anything else in CAD, your computer recognizes it as one entity. If you have a figure made up of three or four elements, your computer treats them as three or four distinct objects. However, when you group the entities together, you are telling the computer to treat them all as one object. As a result, you can select a whole collection of elements with a single click. Your particular program will have some kind of documentation to tell you the exact steps involved.

Each of your futtock pieces is made up of at least four elements, two spline segments and two end pieces. The floor and first futtock have even more. It can be quite annoying to have to select each element in order to select a futtock. For this reason, group all the elements of each futtock into one entity. Selection and movement of the futtocks will be very much easier as a result.

The frame half at this point can be mirror copied about a vertical construction line placed at the midline of the frame (which is also the left most edge). Instantly you see a fully completed frame before you. Trim off the futtock lines.

All the futtock pieces (except the floor) should also be mirror copied. In dealing with only one side of the frame we have focused attention on just one piece, but all the while we have know that a similar piece needed to be produced for the opposite side of the frame. With all the pieces of one side drawn they can be mirror copied. (The axis of copying can be set at any angle, but either horizontal or vertical will suffice.)

For the sake of housekeeping, you might try placing all the futtock pieces near the frame. In fact, you could with a little ingenuity place them all inside the frame itself. The reason for this is to have all the parts of the frame together, so arrange your work accordingly.

So far we have been working in an area of the framing plan. Now we need a file in which to store all our frames. I created a new file for no other purpose than to receive the completed frames. When we finish, this file will have dozens of frames in it and, in real world dimensions, cover 5 acres. This is all in the imagination of the computer, but it illustrates the value of CAD. We can loft the frames in full size (so

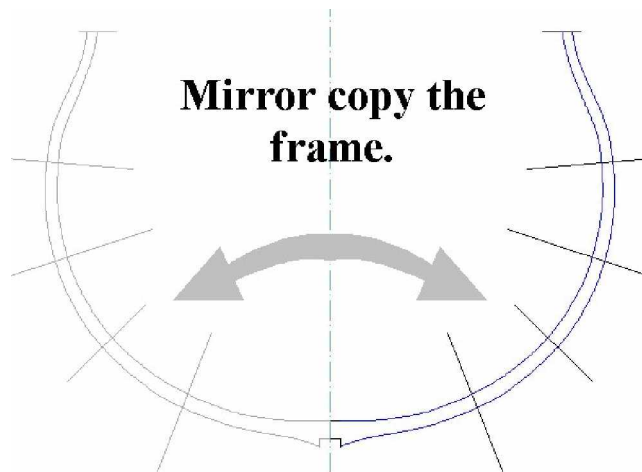



to speak) and worry about reducing them in scale later. This is exactly the opposite practice of the shipwright who drew plans to scale and lofted them out to full dimensions later.

Your work on the frame can now be copied (frame, floor and futtocks) to the new file.

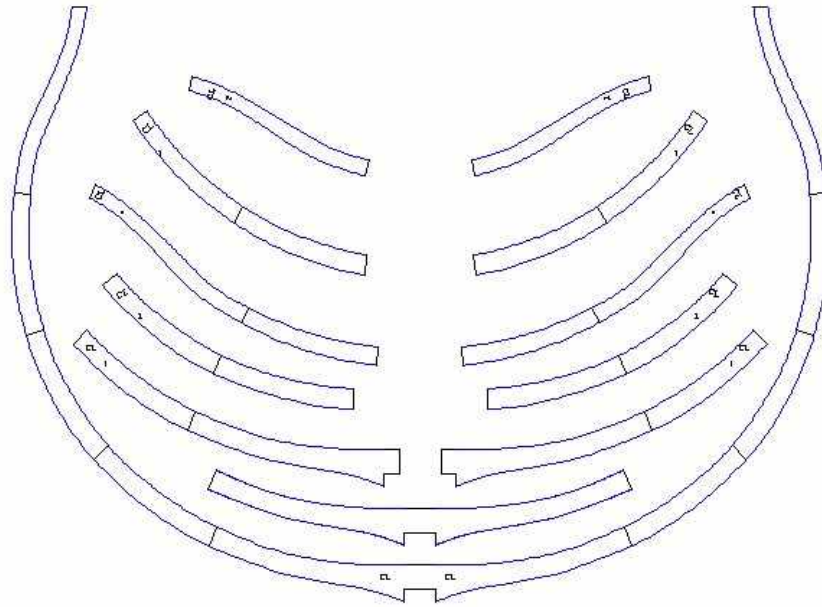

## The frame & its members

**The bevel on the frames** comes into more and more prominence as we move forward and aft of the dead flat frame. I ignored the issue of beveling in order to present a simpler process for lofting out the frame. If you have lofted the dead flat frame without difficulty, then adding the bevel lies well in your grasp.

The bevel of a frame is the angle from the after face to the forward face. On a plan, this is nothing more than the line of the forward face and the after face placed onto one drawing. To indicate this angle is a matter of inserting a repetition of one step into the process of lofting the frame already set forth.

Just after you have drawn in the frame line for, say, the forward face (as we did with the dead flat frame), simply repeat the exact process for the after face. We chose a blue line for the forward face and a red line for the after. Using the same colors consistently gives us a drawing in which a blue line shows the forward face of a frame and a red line the after face.

You probably thought there was something esoteric about all this, but in reality the only trouble you might have is in drawing two lines (the forward and after face lines) that are at points quite close to one another. If you will zoom in for close work (thankful that the different colored lines help in differentiation) you will do fine. Indeed, these lines are so close to one another for many frames that they are hardly worth drawing on a model. A healthy bit of sandpaper will probably set the final bevel at any rate. Even then, however, if you draw in only one face of a frame, you must be absolutely positive you draw in the face furthest out on the outside and furthest in on the inside of the frame. (That is normally the after face for a frame forward of the dead flat and the forward face for a frame aft of the dead flat.) Toward the bow and stern, however, the bevel is sufficient to make a bit of carving down profitable. It is there that drawing in this beveling will help.

Upon further reflection, I should add that it is possible for the after part of a frame to be on the inside of the frame drawing below the waterline and on the outside of the frame above the waterline. This

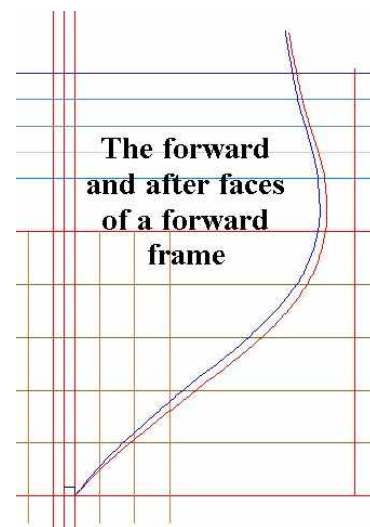



is particularly true at the stern. When a frame has this kind of twist to it, you will have to plot out both faces at any rate in order to produce an accurate frame.

After you think this through for a moment, it is evident that we were following a similar process when we drew in the station lines on the body plan. Each line along with its neighbors indicated a degree of angle to the hull. The station lines were drawn in, at times, quite close to one another. You really should have a great deal of confidence in your ability to draw in the extra line on a frame to indicate the bevel. After all, you essentially have already done it once before on the body plan.

The bevel of the inside of the frame follows the same path. After one face has been drawn in, repeat the process for the other face. The end result will be elegant to look at.

### The Cant Frames

There is no difference in principle in lofting cant frames. A series of construction lines are used to project the shape of the cant frame onto the body plan area. The main additional factor to keep in mind is that the frame is set at an angle to the keel and will, therefore, show a bevel at the centerline in addition to the expected bevels along the sides. The square frames were set on a horizontal plane vis-à-vis the body plan. The cant frames are set at an angle for the moment, but only until we rotate the half breadth plan a

sufficient amount to place the cant frame being projected onto a horizontal plane.

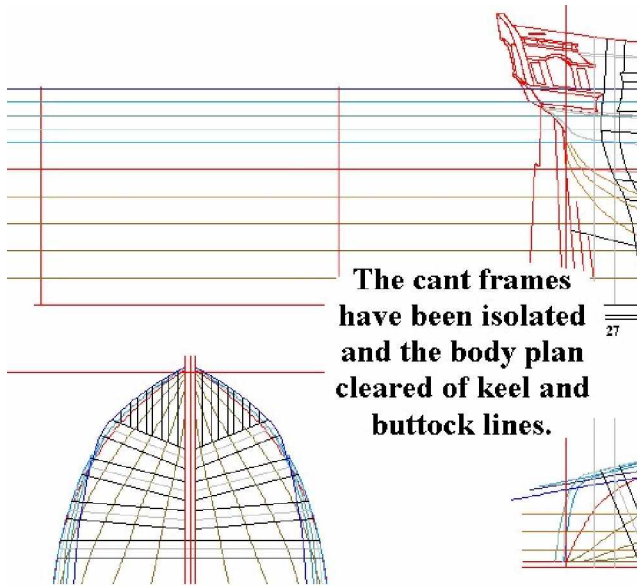

**The cant frames have been isolated and the body plan cleared of keel and buttock lines.**

**To rotate the half breadth plan** returns us to the technique we used to level our photographed and traced plan lines some time ago. The goal is to rotate the half breadth plan in order to bring the cant frame we want to project onto a horizontal line.

We can do this with the entire half breadth plan, rotating it for each cant frame in succession. I have found it somewhat simpler to use only the section of the half breadth plan that contains the cant frames (at the bow and then at the stern). Once more, CAD allows us to produce perfect copies for any part of the whole drawing. One method of isolating just one part of the plan is to draw a box around the cant frames at, say, the bow. Then, trim away everything outside the box and delete the remainder of the plan outside the box as well.

(Of course, you are doing this on a separate working copy of the framing plan.) The box should be erased. Now you have the cant frames available for your work without having to bother with the rest of the plan. This can be done at both the bow and the stern.

We know we can measure the angle of the cant frame, then select the half breadth plan and enter the angle for rotation of the plan. Alternatively, we can place a horizontal construction line down that

coincides with one end of the cant frame. Then, mirror copy the frame line with the horizontal construction line as the axis of copying. After selecting the entire half breadth plan and placing the reference point on the junction of the construction line and the cant frame line, we rotate the selection until the arm of rotation falls on the copy line. As a consequence the cant frame we want to project should be level. The construction line and the copied frame line are then erased.

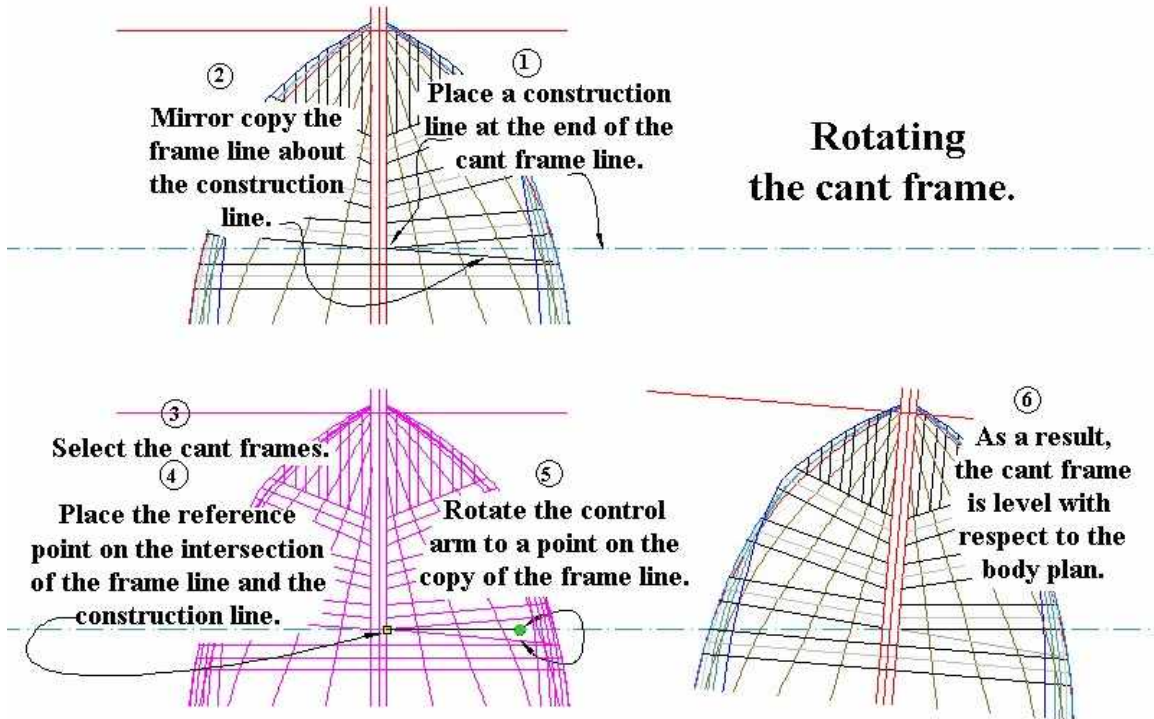

As we draw the cant frames on the body plan, the keel and buttock lines can be eliminated. The square frames used these lines, but in a more technical sense they were simply permanent projections from the half breadth plan. Because the cant frames require the rotation of the frame, the keel line and the buttock lines of the half breadth plan no longer project as straight lines onto the body plan. Hence, they should be removed as we project the cant frames. If this explanation does not impress you, that's fine. But erase the keel and buttock lines on the body plan anyway.

**The same procedure** is used for lofting the cant frames as we used with the square frames with the addition of only a wrinkle or two. Outside lines on the square frames began at the intersection of the side of the keel and the keel line. In essence, the keel line (that is, the bottom of the frame) was projected from the profile plan and the side keel line was projected from the half breadth plan (which you recall was a straight line on both the half breadth and body plans). The fact was that, for the square frames, these reference lines never moved. In the case of the cant frames, however, these lines do shift; but the bottom of the frame is still projected from the profile plan and the side of the keel is still projected from the half breadth plan.

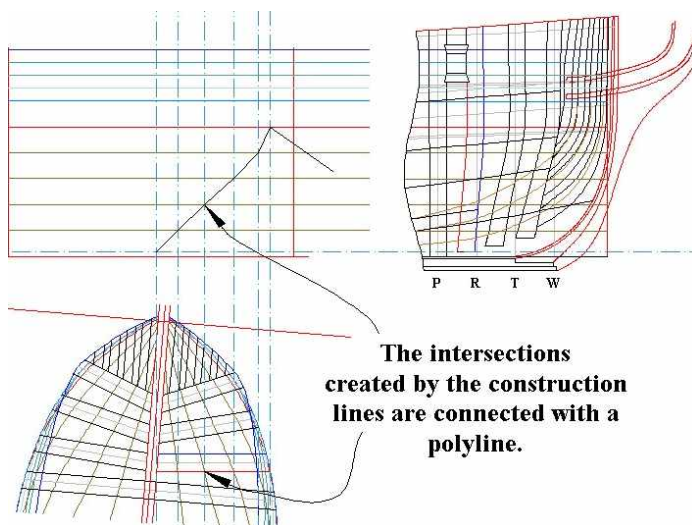

As custom now dictates, the after face of the cant frame is marked in

red and the forward face in blue. For no apparent reason I will start with the after face.

So, we start with a vertical construction line placed on the half breadth plan at the intersection of the after line and the side of the keel. Similarly, we move to the profile plan and place a horizontal construction line on the heel (bottom) of the cant frame. The intersection of these two construction lines on the body plan area defines the lower boundary of the cant frame's after outside line.

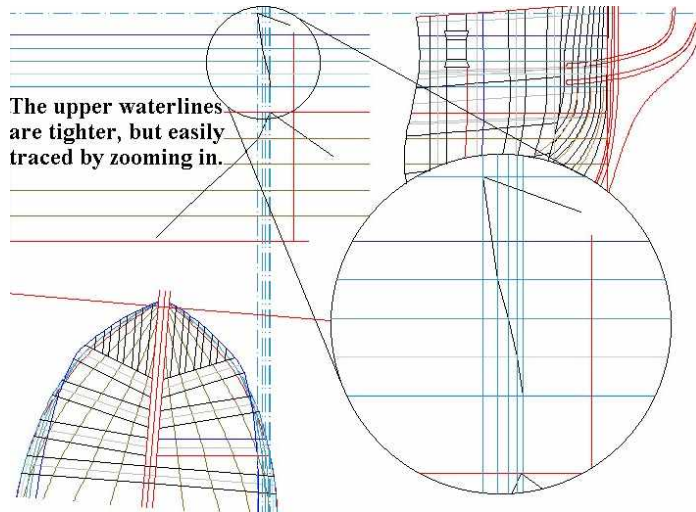

To the half breadth plan we now add vertical construction lines at the intersection of the cant frame line and the waterlines below the wales. Each construction line creates an intersection with its appropriate waterline on the body plan area. As you have surmised, we now connect the keel line intersection and the waterline intersections with a polyline and a tail to one side. The construction lines are now erased.

The waterlines above the wales on the half breadth plan now are marked with vertical construction lines.

On the profile plan the intersection of the cap rail and the frame line is marked with a horizontal construction line. Returning to the body plan, we are set to draw in the cant frame. All the intersection points of the polyline line are traced with the spline tool and then the spline is continued along the intersections defined by the construction lines and waterlines. This is old hat for you by now and the work should go fairly quickly.

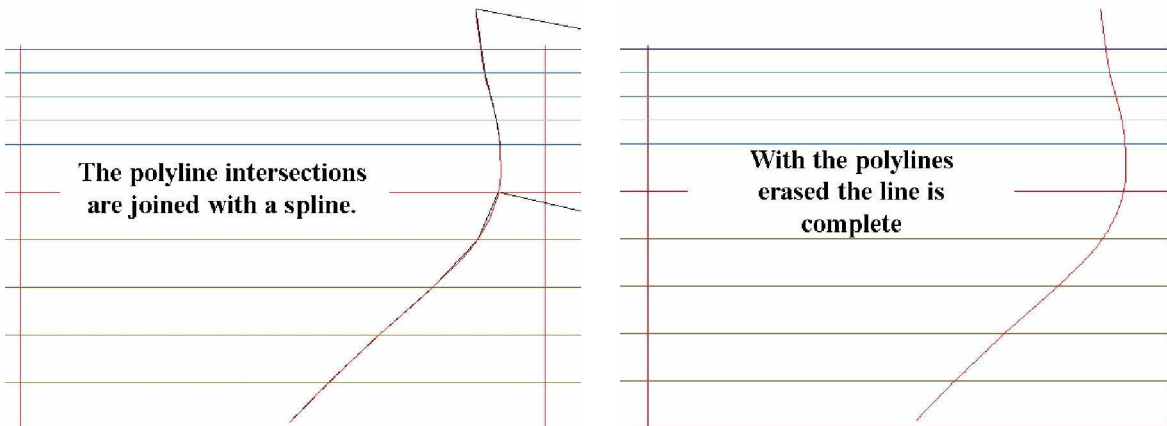

Drawing the inner line of a cant frame differs not at all from the method used with the square frames. The futtock lines are brought over from the profile plan as is the height of the frame at the heel (that is, the cutting down line). Then the widths of the various futtock heads are set down with circles of the appropriate radii. Additional perpendicular construction lines are inserted between the futtock lines with circles of intermediate radii. Finally the intersections of lines and circles are joined with a spline and the inner line has been completed. The only additional factor is that the side of the keel must be set down on the body plan with a vertical line fixed at the end point at the bottom of the frame line.

Right now, the frame appears as it sets flat against the deadwood. When we build the model, the frame could be fixed to the deadwood in this manner, but let us suppose we want to add a shoulder to the frame so that it can be set into the deadwood. This reflects real world practice. I have decided to add to the frame an extra 3 inches for the shoulder. This will match the amount of recess into the deadwood that I will have to incorporate into that piece as well.

At the bottom of the outside line of the frame I place a horizontal line three inches long. A similar line is placed at the bottom of the inside line as well. The ends of the two horizontal lines are joined with a vertical line and the shoulder is complete.

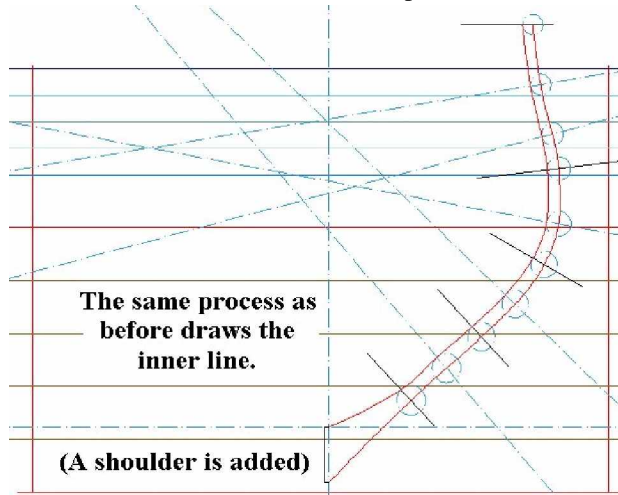

What is good for the after face is good for the forward face. In other words, this procedure is now followed for the forward lines of the cant frame.

For the moment, draw the forward face exactly as you have just done. The work may get a bit close, but it will be no worse than you have already encountered. When you come to drawing the inside line, the futtock lines will already be in place so you have no need to add them. This is one reason we made them a bit longer than their final configuration.

At the heel of the frame you will see two sets of lines representing the shoulder that we decided to put on our frame. A pair of connector lines completes the shoulder. What you have now is a representation of the bevel

that eventually will be cut into the end of the frame. This will set the cant frame at its proper angle to the keel when you cut the frame out and attach it to the deadwood. It can be imagined in this way. Consider that the red lines (the after face) were drawn on one side of the frame and the blue lines (the forward face) were drawn on the opposite side. Consider also that the two sets of lines are aligned with each other perfectly. Now imagine that you carve the end of the frame from the shoulder of the after face to the shoulder of the forward face. To do so you would have to angle the cut to match the angle we desire for the cant frame as a whole vis-à-vis the keel. This, by the way, is exactly the procedure you can use when you cut the frames out for the model. It is the same principle as seen for the bevel along the edges of the frame.

In the course of drawing frames, several approaches have been used to keep the forward and after face lines distinct. One of the most common is to use a dotted line for one face and a solid line for the others. Thanks to CAD's ability to use color, I have chosen to use red and blue lines to assist me in telling the lines apart. The important thing is that you can determine what each line represents on your drawing.

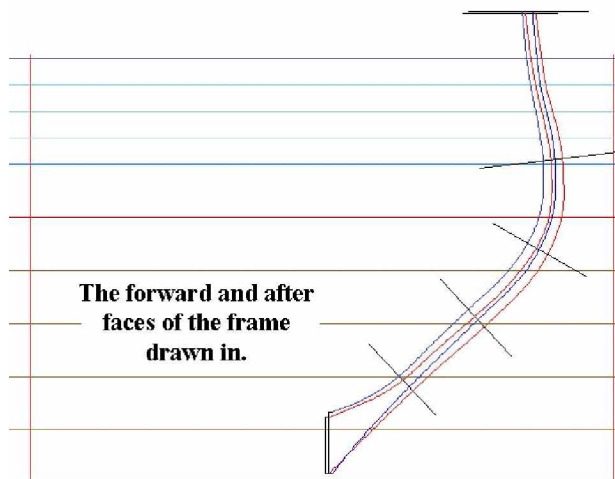

Now the frame can be copied from the body plan area and pasted onto an unused part of the CAD drawing area. As was the case with the square frames, the individual futtock pieces can be extracted. The cant frames are only half frames and therefore will not have a floor piece. The precise number and arrangement of the futtock pieces will depend on the ship, the location of the frame, and your mood at the time.

The final step mirror copies the frame and its futtocks about a vertical line. This creates a perfectly symmetrical frame for the other side of the ship.

Each of the cant frames receives this treatment. The half breadth framing plan is rotated so that the frame in question is level beneath the body plan area. A series of construction lines projects the shape of the frame onto the body plan. After the inner lines are drawn, the drawing is copied off the body plan to a clear area so that the futtock pieces can be segmented out.

For the cant frames at the stern the same process serves well. Again, I might suggest creating a copy of the after cant frames apart from the rest of the rest of the half breadth framing plan. The only purpose for this suggestion is that it makes rotating the plan a bit easier.

## The Hawse Pieces

The good news is that you have already drawn out the outer faces of the hawse pieces. Earlier you drew the hawse pieces on the profile plan. At that time you drew in splines representing the inner and forward edges of each piece. In order to loft out the hawse pieces, we need add the after edge of the piece and indicate the angle at which it joins to the forward most cant frame.

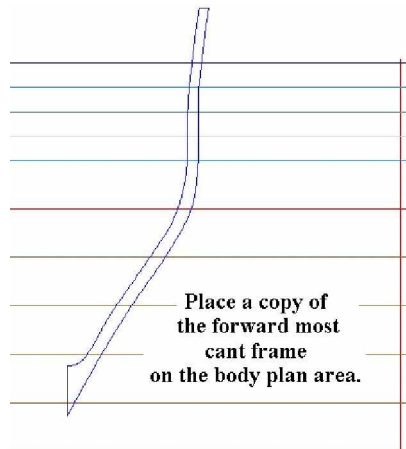

**A copy of the forward most cant frame** should be placed on the body plan area. More precisely, only the forward face of the frame is actually needed since this is the surface to which the hawse pieces are fixed. While it may be a bit of redundancy, you might just as well draw it in with the usual process using construction lines, polylines, etc. The cant frame is used to establish the shape and bevel of the heel of the hawse piece.

**The point at which the hawse piece joins the cant frame** is determined on the profile plan. It is the spot where the inner part of the hawse piece connects to the cant frame. A horizontal construction line should be set at this intersection so as to project this height above the keel. On the body plan this construction line will intersect the cant frame we have placed

there. This is the beginning reference point for placing our hawse piece.

Now select the two lines on the profile plan that represent the hawse piece you are lofting. Paste a copy of these two lines onto the body plan area. Now it is necessary to move the lines so that the inner line of the hawse piece rests on the intersection of the cant frame and the construction line. The astute person will realize that we have simply moved the hawse piece lines directly over to the body plan. The thickness of the cant frame at this junction of cant frame and hawse piece will tell us the dimension of the hawse piece at the lower end.

What follows may resemble the mental equivalent of following a mouse through a maze. Still, all we are doing is projecting measurements from the cant frame to the heel of the hawse piece. When we are done, we will have lines indicating the angle at which the piece should be cut in order to mate properly with the face of the cant frame.

**The dimension lines of the heel** of the hawse piece are drawn in with construction lines. Obviously, the termination of the two hawse lines will be two corners of the heel. We need find the other two corners, connect them, and the heel will be defined.

It should also be intuitive that a line rising straight up from the intersection of the cant frame and the inner hawse line will be an edge that itself terminates where it intersects the top of the cant frame. Thus, we should lay down a vertical construction line at the intersection of the inner hawse line and the cant frame. The intersection of this construction line and the top of the cant frame will be the third point.

The fourth point will lie directly above the outer hawse line (i.e., it will be the upper limit of the other vertical edge of the heel). For this reason we lay down a vertical construction line at the end point of the outer hawse line. Stay with me for a few more sentences. We now set down a horizontal construction line at the end point of the outer hawse line. We then place a vertical construction line where the horizontal

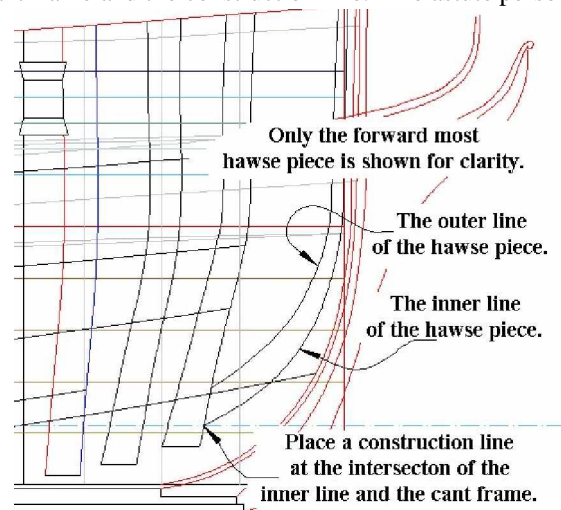

line intersects the lower cant frame line. Now, we place a horizontal construction line at the intersection of this new vertical construction line and the top of the cant frame. Follow this horizontal line over to its intersection with the vertical line that rises from the end point of the outer hawse line. This intersection is the fourth point defining the heel of the hawse piece.

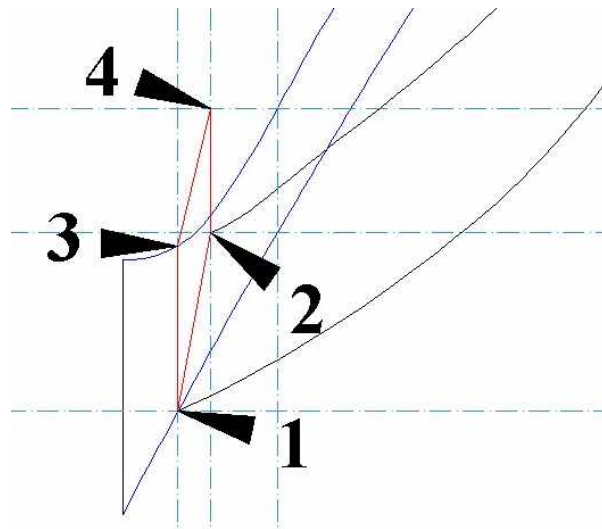
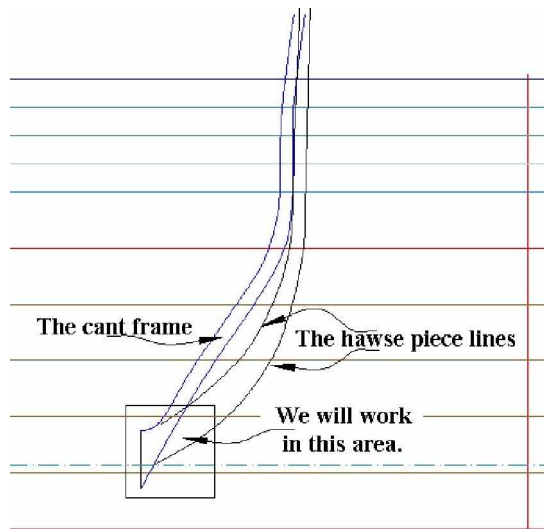

If you are confused, just think and work it through. If this makes sense to you without doing the drawing, you indeed have a level of contemplative prowess worthy of admiration. Draw it out, though. The construction lines and the cant frame are no longer needed and can be discarded. (On the other hand, keep in mind you will need the cant frame to draw out the remaining hawse pieces, so keep it handy to be put back in place for the next piece.)

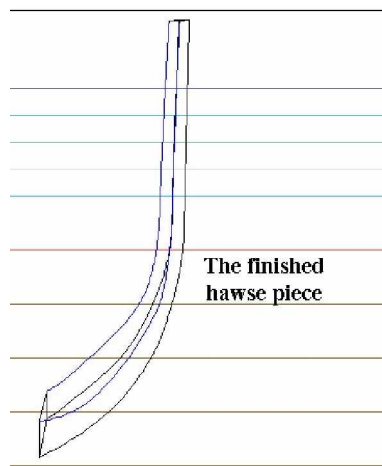

**The inside lines of the hawse piece** are drawn in with the same process as we used for the other frames. Let the futtock lines on the profile plan determine the placement of horizontal construction lines. On the body plan these tell us where to construct perpendiculars on the hawse piece lines. Circles of the appropriate radii are then used to define the width of the piece. A spline beginning at the upper heel corners and following the intersections of circles and perpendiculars completes the inside edges. The erasure of the construction lines and circles leaves the hawse piece.

**Both the hawse pieces and the cant frames** should be mirror copied. CAD allows us to create just one side of the framing and let the computer duplicate our work for the other side.

### A Parting Note

The work we have done on the frames is repetitive and, for that reason, goes rather quickly once you have the procedures down. Remember to group each frame and frame piece into a single object for ease of selection later on. You also will probably want to arrange your collection of frames on a single drawing. The manner in which you do so is up to you.

If you have traveled this far with me I should think you have become quite adept at projecting information from one plan to another through the use of construction lines. There is an enjoyment in the sense of accomplishment that comes when you have finished lofting out a set of frames for your ship.